



**BURG
WÄCHTER**

ALWAYS THE
SAFE CHOICE!



Safes





Commercial Freestanding Safes – Diplomat



FIRE RESISTANCE GRADE LFS 60 P
Certified protection against fire



RESISTANCE GRADE I
Certified protection against burglary



Currently the only certified safe lock with fingerscan module



Version E:
with fingerscan module



MTD 34 F60 - MTD 38 F60 commercial freestanding safes 'Diplomat' **RESISTANCE GRADE I, FIRE RESISTANCE GRADE LFS 60 P**

- type tested and supervised security by ECB-S/VdS
- certified protection against burglary and fire
- 3 walled body with armoured, special fireproof insulation
- BURG-WÄCHTER special insulation in body and door – FPC buildup (Fire Protection Concrete)
- special rear wall construction with additional armoring – advantage: low overall depth due to slim overall design
- optimal use of internal space due to slim body and door – 4-walled door
- extensive armoring in front of bolt work and locking bolt
- 4-sided locking through strong round bolts
- specially concealed hinges
- prepared for wall and floor anchoring, includes fixings
- **Security advantage:** double emergency locking system, not resettable
- convenient depth for common sized files
- adjustable shelf
- metallic silver colour as standard, special paint on request
- recessed door
- intumescent seal, swells and seals the door in event of fire



SecuTronic – the first biometric safe lock with VdS certification.

- developed by BURG-WÄCHTER
- VdS approved safe lock with fingerscan module, EN 1300 class 2
- programmable electronic lock
- in addition to the 10 x 6-digit pincodes, you can program up to 20 fingerprints
- when opening with fingerscan, 2 different fingers have to be programmed/entered
- 1.000.000 combinations possible

- the scanner only works with 'real, live, fingers'; fake fingers or copies will not be identified
- this precise and highly sensitive procedure of authentication operates with different dermal conditions, from extremely dry to more humid skin
- the opening of a safe by using the fingerscan is very quick and comfortable



SecuSafe – the resettable high security safe lock

- class B according to EN 1300
- 10 levers
- 50.000.000 key differs
- in case of loss a new key can be programmed straight away
- Multiple safes can be instantly re-programmed by the user to be keyed alike. This is ideal for customers who want more than one safe to work with the same key.
- can be supplied with additional keys at the time of purchase
- for more information regarding spare keys and additional keys see page 152

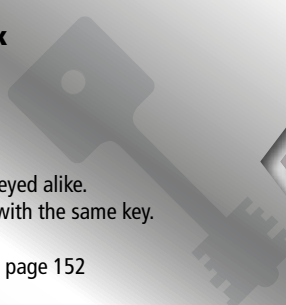



Commercial Freestanding Safes – Diplomat



Version S

Resettable, armoured high-security safe lock, 'SecuSafe', VdS tested, ECB-S certified according to EN 1300 class B, 10 levers, key retaining, 50.000.000 key differs. More security in case of losing the key – immediately resettable to a new key. The locking armature protrudes 13 mm.



For more information regarding spare keys and additional keys see page 152.

Art.-No.	EAN	Exterior H x W x D	Interior H x W x D	Door H x W	Weight	Volume
	40 03482...	mm	mm	Opening mm	kg	l
MTD 34 F60 S	37500 6	380 x 500 x 462	255 x 370 x 300	255 x 337	112	28,3
MTD 35 F60 S	37520 4	470 x 500 x 462	345 x 372 x 300	345 x 337	130	38,5
MTD 36 F60 S	37540 2	625 x 500 x 462	500 x 372 x 300	500 x 337	161	55,8
MTD 38 F60 S	37560 0	985 x 500 x 462	860 x 372 x 300	860 x 337	233	96,0



MTD 34 F60 S



Version E

Electronic combination lock 'SecuTronic' with integrated fingerscan module, VdS approved, class 2. With intelligent menu-driven operation, administration of up to 10 user codes, up to 20 fingerscans and up to 300 optional TSE E-KEY. User names, access times and rights, calendar functions, etc. programmed via optional TSE PC software packages. Incl. 2 batteries Mignon LR 6 AA. The locking armature protrudes 27 mm.



Art.-No.	EAN	Exterior H x W x D	Interior H x W x D	Door H x W	Weight	Volume
	40 03482...	mm	mm	Opening mm	kg	l
MTD 34 F60 E	37510 5	380 x 500 x 462	255 x 370 x 300	255 x 337	112	28,3
MTD 35 F60 E	37530 3	470 x 500 x 462	345 x 372 x 300	345 x 337	130	38,5
MTD 36 F60 E	37550 1	625 x 500 x 462	500 x 372 x 300	500 x 337	161	55,8
MTD 38 F60 E	37570 9	985 x 500 x 462	860 x 372 x 300	860 x 337	233	96,0



MTD 35 F60 E

Accessories

Art.-No.	EAN	
	40 03482...	
IT MTD	37960 8	interior safe for MTD F60 (H 180 x W 372 x D 260 mm)

Special paintwork Diplomat

Paintwork/Size	EAN	Paintwork/Size	EAN
	40 03482...		40 03482...
RAL, MTD 34/35	35010 2	Brilliant, MTD 34/35	34000 4
RAL, MTD 36	35011 9	Brilliant, MTD 36	36000 2
RAL, MTD 38	35012 6	Brilliant, MTD 38	34010 3

Optimal utilisation of the interior space

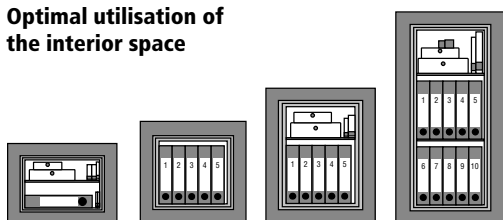

Certifications and security levels, see page 158-159.

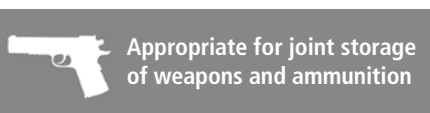

MTD 34 F60 MTD 35 F60 MTD 36 F60 MTD 38 F60



MTD 36 F60 E



MTD 38 F60 E

BURG-WÄCHTER Security-Level

	LEVEL	0	10	20
	LEVEL	0	10	20
	LEVEL	0	10	20
	LEVEL	0	10	20

ISO 9001 CERTIFIED
BURG-WÄCHTER
MEMBER OF PENTON

QUALITY MADE IN GERMANY



Domestic Freestanding safes – Karat



Stainless steel body
Flame cutting protection



RESISTANCE GRADE 0
Certified protection against burglary



Currently the only certified
safe lock with
fingerscan module



Version E:
optionally available with
fingerscan module



MT 24 N - MT 26 N domestic freestanding safes 'Karat'

RESISTANCE GRADE 0

- type tested and supervised security by ECB-S
- protected against burglary and fire
- triple walled body with exterior walls of flame-cutting protected stainless steel material
- double-walled door with additional armoring, door leaf thickness 7 mm SM steel
- additional lock plating for extra protection
- three-sided locking through strong square bolts, bolts on the top and on the bottom with integrated steel rolls - extreme protection against flame-cutting, drilling and attack
- all-over gripping bar on the hinge side
- prepared for both wall and floor fixing, fixings included – extreme high breaking strength. 1 centrally arranged drill hole on the back wall and 1 on the bottom.
- fire-protective material in body and door according to DIN 4102-A1
- convenient depth for common sized files, 1 adjustable shelf
- colour: platinum grey (similar to RAL 9007)

security advantage:

- special protection against drilling
- thermal emergency locking mechanism in front of each bolt



SecuTronic – the first biometric safe lock with VdS certification.

- developed by BURG-WÄCHTER
- VdS approved safe lock with fingerscan module, EN 1300 class 2
- programmable electronic lock
- in addition to the 10 x 6-digit pincodes, you can program up to 20 fingerprints
- when opening with fingerscan, 2 different fingers have to be programmed/entered
- 1.000.000 combinations possible

- the scanner only works with 'real, live, fingers'; fake fingers or copies will not be identified
- this precise and highly sensitive procedure of authentication operates with different dermal conditions, from extremely dry to more humid skin
- the opening of a safe by using the fingerscan is very quick and comfortable

VdS TESTED Currently the only certified safe lock with fingerscan module

SecuSafe – the resettable high security safe lock

- class B according to EN 1300
- 10 levers
- 50.000.000 key differs
- in case of loss a new key can be programmed straight away
- Multiple safes can be instantly re-programmed by the user to be keyed alike. This is ideal for customers who want more than one safe to work with the same key.
- can be supplied with additional keys at the time of purchase





Domestic Freestanding safes – Karat



Version S

Resettable, armoured high-security safe lock 'SecuSafe', ECB-S certified according to EN 1300 class B, with 2 keys, 10 levers, key retaining, 50.000.000 key differs. More security in case of losing the key – immediately resettable to a new key. The locking armature protrudes 3 mm.

For detailed information regarding the resettable high security safe lock TRS 22 see p. 130.

Art.-No.	EAN	Exterior H x W x D	Interior H x W x D	Door H x W	Weight	Volume
	40 03482...	mm	mm	Opening mm	kg	l
MT 24 N S	16050 3	340 x 430 x 390	250 x 348 x 294	250 x 336	43	25,8
MT 26 N S	19090 6	530 x 430 x 390	440 x 348 x 294	440 x 336	60	45,3



MT 24 N S

Spare keys and additional keys for MT 24-26 N S and C 1-4 S

Key sets	EAN	
	40 03482...	
Set 55-80-2	08890 6	Key set 55-80-2: two key set, length: 80 mm
Set 55-80-4	08910 1	Key set 55-80-4: four key set, length: 80 mm
Set 55-80-6	06880 9	Key set 55-80-6: six key set, length: 80 mm
as per sample	08640 7	Key as per sample, lock class B, length of key 80 mm



MT 26 N S



Version E

Electronic combination lock 'SecuTronic', ECB-S certified according to EN 1300 class B, with intelligent menu-driven operation, administration of up to 10 users, 1.000.000 different combinations and up to 300 optional TSE E-KEY possible. User names, access times and rights, calendar functions, can be programmed via optional TSE PC software. Incl. 2 batteries Mignon LR 6 AA. The locking armature protrudes 16 mm.

Art.-No.	EAN	Exterior H x W x D	Interior H x W x D	Door H x W	Weight	Volume
	40 03482...	mm	mm	Opening mm	kg	l
MT 24 N E	19150 7	340 x 430 x 390	250 x 348 x 294	250 x 336	43	25,8
MT 26 N E	19020 3	530 x 430 x 390	440 x 348 x 294	440 x 336	60	45,3



MT 24 N E



Version E FS

Electronic combination lock 'SecuTronic' with integrated fingerscan module, VdS approved. With intelligent menu-driven operation, administration of up to 10 user codes, up to 20 fingerscans and up to 300 optional TSE E-KEY. User names, access times and rights, calendar functions, can be programmed via optional TSE PC software. Incl. 2 batteries Mignon LR 6 AA. The locking armature protrudes 30 mm.

Art.-No.	EAN	Exterior H x W x D	Interior H x W x D	Door H x W	Weight	Volume
	40 03482...	mm	mm	Opening mm	kg	l
MT 24 N E FS	32280 2	340 x 430 x 390	250 x 348 x 294	250 x 336	43	25,8
MT 26 N E FS	32290 1	530 x 430 x 390	440 x 348 x 294	440 x 336	60	45,3



MT 26 N E FS



Appropriate for joint storage of weapons and ammunition

BURG-WÄCHTER Security-Level



Optimal utilisation of the interior space

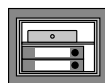

MT 24 N

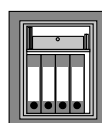

MT 26 N



Safety cabinets – Combi-Line



FIRE RESISTANCE GRADE LFS 30 P
Certified protection against fire



RESISTANCE GRADE S2
Certified protection against burglary



Currently the only certified safe lock with fingerscan module



Version E:
optionally available with fingerscan module



CL 10 - CL 40 Safety cabinets 'Combi-Line'

SECURITY LEVEL S 2
FIRE RESISTANCE GRADE LFS 30 P

- BURG-WÄCHTER safety cabinets with a certification which is valid all over Europe. For the safe storage of documents, cash, jewellery, arms or ammunition, coins and valuables.
- security Level S 2 according to DIN EN 14450
- security Level B according to VDMA 24992, May 1995
- fire resistance LFS 30 P according to EN 15659 – 30 minutes fire protection for paper
- fire-protective material according to DIN 4102
- composite insulation in front of the door leaf provides heat protection for the lock and bolts
- tested and certified protection against burglary and fire

- double-walled construction
- internal hinge
- lateral locking through 25mm diameter strong round bolts plus sliding bolt on the top
- all-over gripping rail on the hinge side
- prepared for both wall and floor fixing, fixings included - extreme high breaking strength, 2 diagonally arranged drill holes on the back wall and 2 on the bottom
- colour: body grey, door light grey
- model S supplied with 2 keys
- standard series with 1 shelf each

SecuTronic – the first biometric safe lock with VdS certification. Developed by BURG-WÄCHTER.

- certified safe lock with integrated fingerscan module according to VdS, EN 1300 class 1
- programmable electronic combination lock 'SecuTronic' with integrated fingerscan module
- in addition to a 6-digit user programmed code, up to 10 fingers can be programmed
- 1.000.000 different combinations possible

- when opening with fingerscan, 2 different fingers have to be programmed/entered
- the scanner only works with 'real, live, fingers'. Fake fingers or copies will not be identified
- the precise and highly sensitive procedure of authentication operates with different dermal conditions, from extremely dry up to humid skin
- the opening of a safe by using the fingerscan is very quick and comfortable

VdS TESTED
Currently the only certified safe lock with fingerscan module

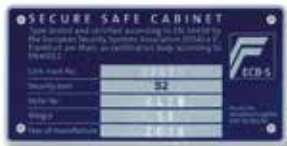

3 security standards in one safe.

The safety cabinets Combi-Line correspond to 3 security standards:

- level B according to VDMA24992, 5/95
- level S 2 according to DIN EN 14450
- fire resistance LFS 30 P according to EN 15659 - 30 minutes fire protection for paper

Technical features.

Sliding bolt on the top with additional protection against attack.





Safety cabinets – Combi-Line



Version S

Security safe lock 'SecuSafe', VdS tested, ECB-S certified according to EN 1300 class A, 9 levers, more than 1.000.000 key differs.

Art.-No.	EAN	Exterior H x W x D mm	Interior H x W x D mm	Door H x W Opening mm	Weight kg	Volume l
CL 10 S	33400 3	320 x 435 x 380	205 x 320 x 232	205 x 265	44	15
CL 20 S	33420 1	360 x 495 x 445	245 x 380 x 297	245 x 325	55	27
CL 40 S	33440 9	560 x 495 x 445	445 x 380 x 297	445 x 325	77	50

Key blank for CL 10-40 S

Key	EAN	
	40 03482...	
As per sample	16620 8	Length of key 80 mm
Key blank 55	33610 6	Key blank, PU 3 pcs.



CL 10 S



Version E

Electronic combination lock 'SecuTronic', VdS tested, ECB-S certified according to EN 1300 class B, 1.000.000 different combinations possible, incl. 3 batteries, type Micro LR 03 AAA. The locking armature protrudes 7 mm.

Art.-No.	EAN	Exterior H x W x D mm	Interior H x W x D mm	Door H x W Opening mm	Weight kg	Volume l
CL 10 E	33410 2	320 x 435 x 380	205 x 320 x 232	205 x 265	44	15
CL 20 E	33430 0	360 x 495 x 445	245 x 380 x 297	245 x 325	55	27
CL 40 E	33450 8	560 x 495 x 445	445 x 380 x 297	445 x 325	77	50



CL 20 S

Available from 2nd quarter 2014

Programmable electronic lock 'SecuTronic' with integrated fingerscan module, VdS certified according to EN 1300 class 1, 1,000,000 different combinations possible. Includes batteries, including batteries, in addition to a 6-digit user-programmed numerical code up to 10 fingers can be programmed, for opening with a fingerscan two fingers must be programmed/entered. The locking armature protrudes 13 mm.



Version E FS

Art.-No.	EAN	Exterior H x W x D mm	Interior H x W x D mm	Door H x W Opening mm	Weight kg	Volume l
CL 10 E FS	33460 7	320 x 435 x 380	205 x 320 x 232	205 x 265	44	15
CL 20 E FS	33470 6	360 x 495 x 445	245 x 380 x 297	245 x 325	55	27
CL 40 E FS	33480 5	560 x 495 x 445	445 x 380 x 297	445 x 325	77	50



CL 20 E



Appropriate for storage of weapons or ammunition

Optimal utilisation of the interior space



CL 10

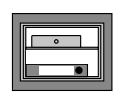

CL 20

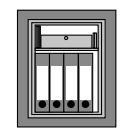

CL 40

BURG-WÄCHTER Security-Level

	LEVEL	0	10	20
	LEVEL	0	10	20
	LEVEL	0	5	10
	LEVEL	0	7	10
	LEVEL	0	8	10

ISO 9001 CERTIFIED
BURG WÄCHTER
MEMBER OF VDMA

GERMAN ENGINEERING
QUALITY



CL 40 E FS



Freestanding Home Safes – CityLine, HomeSafe



Freestanding home safes 'CityLine' SECURITY LEVEL B

- security level B according to VDMA 24992, 5/95
- double-walled
- fire-protective material according to DIN 4102-A1
- specially designed fire fold
- effective locking mechanism with round bolts
- prepared for both wall and floor fixing, 2 diagonally arranged drill holes on the back wall and 2 on the bottom
- for common sized files
- 2 keys included
- colour: light grey



C 1 S

Resettable, armoured high-security safe lock 'SecuSafe', ECB-S certified according to EN 1300 class B, with 2 keys, 10 levers, key retaining, 50.000.000 key differs. More security in case of losing the key – immediately resettable to a new key. The locking armature protrudes 5 mm.



Version S

For detailed information regarding resettable high security safe lock 'SecuSafe' see p. 130.

Art.-No.	EAN	Exterior H x W x D mm	Interior H x W x D mm	Door H x W Opening mm	Weight kg	Volume l
C 1 S	14880 8	278 x 402 x 376	209 x 336 x 294	209 x 326	30,0	20,6
C 4 S	14070 3	528 x 435 x 382	440 x 350 x 292	440 x 345	49,0	45,3

Replacement and additional keys for C 1 S and C 4 S, see p. 131.



NEW!

Now with resettable high security lock!



Version E

Electronic combination lock 'SecuTronic', ECB-S certified according to EN 1300 class B, 1.000.000 different combinations possible, incl. batteries. The locking armature protrudes 13 mm.

Art.-No.	EAN	Exterior H x W x D mm	Interior H x W x D mm	Door H x W Opening mm	Weight kg	Volume l
C 1 E	26490 4	278 x 402 x 376	209 x 336 x 294	209 x 326	30,0	20,6
C 4 E	14080 2	528 x 435 x 382	440 x 350 x 292	440 x 345	49,0	45,3

Optimal utilisation of the interior space

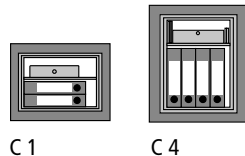

BURG-WÄCHTER Security-Level

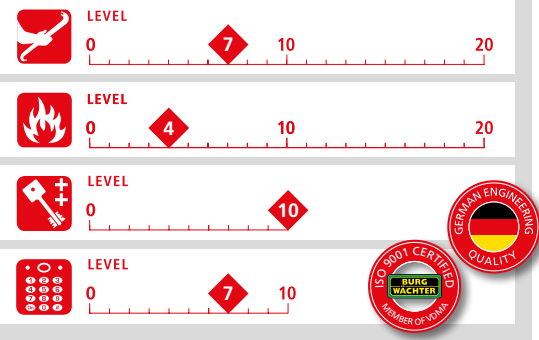

Freestanding home safe HomeSafe H 1 SECURITY LEVEL B

- double-walled
- security level B according to VDMA 24992, 5/95
- with fire-protective material
- prepared for both wall and floor fixing
- for common sized files



H 1 S



Version S

Security safe lock 'SecuSafe', VdS tested, ECB.S certified according to EN 1300 class A, with 2 keys, 9 levers, more than 1.000.000 key differs.

Art.-No.	EAN	Exterior H x W x D mm	Interior H x W x D mm	Door H x W Opening mm	Weight kg	Volume l
H 1 S	14900 3	278 x 402 x 376	209 x 336 x 294	209 x 326	30,0	20,6



Version E

Electronic combination lock 'SecuTronic', VdS tested, ECB.S certified according to EN 1300 class B, 1.000.000 different combinations possible, incl. batteries. The locking armature protrudes 13 mm.

Art.-No.	EAN	Exterior H x W x D mm	Interior H x W x D mm	Door H x W Opening mm	Weight kg	Volume l
H 1 E	26290 0	278 x 402 x 376	209 x 336 x 294	209 x 326	30,0	20,6



H 1 E

Freestanding HomeSafes



Freestanding HomeSafe H3

SECURITY LEVEL A

- single walled home safe, compact - fits onto every shelf
- security level A according to VDMA 24992, 5/1995
- single walled body
- double-walled door
- effective square bolt locking
- prepared for double wall fixing, with fixing material, 2 drill holes at half height on the back wall
- ideal for A4 documents
- 2 keys included
- includes one shelf
- colour: black



Version S

Security safe lock 'SecuSafe', ECB-S certified according to EN 1300 class A, with 2 keys, 9 levers, more than 1.000.000 key differs.

Art.-No.	EAN	Exterior H x W x D	Interior H x W x D	Door H x W	Weight	Volume
	40 03482...	mm	mm	Opening mm	kg	l
H 3 S	25000 6	257 x 347 x 298	216 x 340 x 243	184 x 276	16,0	17,8

Key blank for H 3 S

Key	EAN	
	40 03482...	
As per sample	16620 8	Length of key 68 mm
Key blank 51	16670 3	Key blank, PU 3 pcs.



H 3 S



Version E

Electronic combination lock 'SecuTronic', ECB-S certified according to EN 1300 class B, 1.000.000 different combinations possible, incl. batteries. The locking armature protrudes 9 mm.

Art.-No.	EAN	Exterior H x W x D	Interior H x W x D	Door H x W	Weight	Volume
	40 03482...	mm	mm	Opening mm	kg	l
H 3 E	25020 4	257 x 347 x 298	216 x 340 x 243	184 x 276	16,0	17,8



H 3 E

Freestanding home safe HomeSafe H 3 with slot

- with slot 230 x 8 mm
- ideal for fast and safe storage of banknotes or envelopes
- light weight of 16 kg, makes this safe ideal for mobile use, for example, at events etc.
- colour: black
- technical features as per H 3 safes above
- **version S:** Security safe lock - VdS tested; ECB-S certified according to EN 1300 class A, 9 levers, more than 1.000.000 key differs
- **version E:** Electronic combination lock 'SecuTronic', VdS tested; ECB-S certified according to EN 1300 class B. 1.000.000 different settings possible. Incl. 3 batteries (Micro LR 03 AAA). The locking armature protrudes 9 mm.

Art.-No.	EAN	Exterior H x W x D	Interior H x W x D	Door H x W	Weight	Volume
	40 03482...	mm	mm	Opening mm	kg	l
H 3 S C4 EWS	26090 6	257 x 347 x 298	216 x 340 x 243	184 x 276	16,0	17,8
H 3 E C4 EWS	26190 3	257 x 347 x 298	216 x 340 x 243	184 x 276	16,0	17,8



H 3 E C4 EWS

BURG-WÄCHTER Security-Level

LEVEL 5 (Vandalism)

LEVEL 2 (Fire)

LEVEL 5 (Mechanical)

LEVEL 7 (Electronic)

ISO 9001 CERTIFIED MEMBER OF VDMA

QUALITY MADE IN GERMANY



Freestanding Home Safes – PointSafe



P 1 S

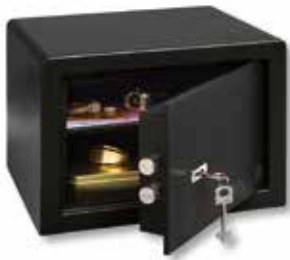

P 2 S



P 3 E



P 3 E FS



P 4 E FS

Freestanding home safes PointSafe P 1 - P 4

- tested in the BURG-WÄCHTER laboratory
- solid single-walled body
- double-walled door
- prepared for wall and floor fixing
2 drill holes at half height on the back wall
2 drill holes at half depth on the bottom,
fixings included
- can be installed in cupboards, desks, etc.
- size P 1 and P 2: without shelf
- size P 3 and P 4: removable shelf
- size P 3 and P 4: for files of common size
- colour: black (similar to RAL 9004)



Version S

with safe lock and 2 keys, 100.000 key differs

Art.-No.	EAN	Exterior H x W x D	Interior H x W x D	Door H x W	Weight	Volume
	40 03482...	mm	mm	Opening mm	kg	l
P 1 S	24840 9	180 x 280 x 200	173 x 273 x 141	135 x 188	7,5	6,7
P 2 S	24850 8	255 x 350 x 300	248 x 343 x 241	188 x 230	14,0	20,5
P 3 S	24950 5	320 x 442 x 350	310 x 435 x 288	240 x 317	20,0	38,8

Key blank for P 1-P 3 S

Key	EAN	
	40 03482...	
As per sample	33000 5	Length of key 76 mm
Key blank 17 B	16810 3	Key blank, PU 5 pcs.



Version E

Electronic combination lock with user programmed master, and user codes. User code can be changed at any time. Smooth motor powered locking mechanism automatically opens the door. No electrical supply necessary, 4 x Mignon LR6 AA batteries included. Also has mechanical emergency over-ride lock. The locking armature protrudes 13 mm.

Art.-No.	EAN	Exterior H x W x D	Interior H x W x D	Door H x W	Weight	Volume
	40 03482...	mm	mm	Opening mm	kg	l
P 1 E	26760 8	180 x 280 x 200	173 x 273 x 141	135 x 188	7,5	6,7
P 2 E	24810 2	255 x 350 x 300	248 x 343 x 241	188 x 230	14,0	20,5
P 3 E	24820 1	320 x 442 x 350	310 x 435 x 288	240 x 317	20,0	38,8
P 4 E	24830 0	500 x 416 x 350	490 x 410 x 288	423 x 290	25,5	57,9



Version E FS

Electronic combination lock with high quality fingerscan technology and user programmed master, and user codes. User code and fingerscans can be changed at any time. Smooth motor powered locking mechanism automatically opens the door. No electrical supply necessary, 4 x Mignon LR6 AA batteries included. Also has mechanical emergency over-ride lock. The locking armature protrudes 15mm.

Art.-No.	EAN	Exterior H x W x D	Interior H x W x D	Door H x W	Weight	Volume
	40 03482...	mm	mm	Opening mm	kg	l
P 2 E FS	35390 5	255 x 350 x 300	248 x 343 x 241	188 x 230	14,0	20,5
P 3 E FS	35360 8	320 x 442 x 350	310 x 435 x 288	240 x 317	20,0	38,8
P 4 E FS	35380 6	500 x 416 x 350	490 x 410 x 288	423 x 290	25,5	57,9

Enhanced protection against burglary and drilling!
Reinforced door leaf and locking bolts plates in front of the bolts as protection against drilling

BURG-WÄCHTER Security-Level

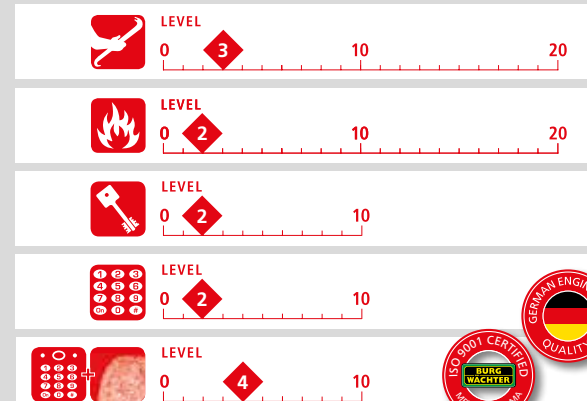

Hotel Safes, Laptop Safe



Point-Safe 3 E Lap

- laptop safe with electronic lock
- solid single-walled body
- prepared for wall fixing, fixings included.
- can be installed in cupboards, desks, etc.
- with self-programmable electronic combination lock
- for files and laptops



Version E

Electronic combination lock with user programmed master, and user codes. User code can be changed at any time. Smooth motor powered locking mechanism automatically opens the door. No electrical supply necessary, 4 x mignon LR6 AA batteries included. Also has mechanical emergency over-ride lock. The locking armature protrudes 13 mm.

Art.-No.	EAN	Exterior H x W x D	Interior H x W x D	Door H x W	Weight	Volume
	40 03482...	mm	mm	Opening mm	kg	l
Point 3 E Lap	18180 5	200 x 445 x 380	196 x 441 x 323	140 x 380	15,2	27,9



P 3 E Lap



Version E FS

Electronic combination lock with high quality fingerscan technology and user programmed master, and user codes. Fingerscans and user code can be changed at any time. Smooth motor powered locking mechanism automatically opens the door. No electrical supply necessary, 4 x Mignon LR6 AA batteries included. Also has mechanical emergency over-ride lock. The locking armature protrudes 13 mm.

Art.-No.	EAN	Exterior H x W x D	Interior H x W x D	Door H x W	Weight	Volume
	40 03482...	mm	mm	Opening mm	kg	l
Point 3 E FS Lap	35370 7	200 x 445 x 380	196 x 441 x 323	140 x 380	15,2	27,9



P 3 E FS Lap



Also available in hotel version!



Hotel safes

with user programmed electronic lock and keyed-alike emergency opening lock



Art.-No.	EAN	Exterior H x W x D	Interior H x W x D	Door H x W	Weight	Volume
	40 03482...	mm	mm	Opening mm	kg	l
P 1 E KA 3	37770 3	180 x 280 x 200	173 x 273 x 141	135 x 188	7,5	6,7
P 3 E KA 4	37780 2	320 x 442 x 350	310 x 435 x 288	240 x 317	20,0	38,8
P 3 E Lap KA 4	37790 1	200 x 445 x 380	196 x 441 x 323	140 x 380	15,2	27,9

The ideal safe for hotel use

- **version KA3 and KA4:** with keyed-alike emergency opening lock
- **for the hotelier:** superior hotel Master code for all safes - user programmable
- **for the hotel guest:** easy to understand short instructions



P 1 E KA 3

Subject to errors and changes.

Minor variations of sizes and weight depend on production characteristics.



Fire protective safe, Compact freestanding home safes



FP 4 E

Fire protective safes

- document safe – certified protection against fire
- body and door double-walled
fully filled with insulating concrete
- door with double-sided locking
- safe tested to keep interior below 177° C for 1 hour in the event of fire - Good protection for your documents
- body with specially designed fire fold
- prepared for floor fixing – fixing included
- with modern, user programmed electronic combination lock
- you can change your secret code at any time
- with user code and master code
- battery operated (4 x 1,5 V Mignon)
- no electrical supply necessary
- additional lock for emergency opening
- the locking armature protrudes 20 mm

Art.-No.	EAN	Exterior H x W x D	Interior H x W x D	Weight	Volume
	40 03482...	mm	mm	kg	l
FP 4 E	20380 4	345 x 485 x 400	218 x 358 x 268	38,0	20,0

Tip:
Combi-Line and
Diplomat safes with
protection against
burglary **and** fire
(see p. 128 and 132)

BURG-WÄCHTER Security-Level

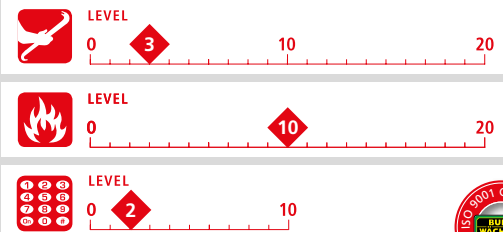

Smart 2E

Smart Safe 2 E

- single-walled
- compact freestanding home safe
- re-programmable electronic lock
- emergency override lock

Art.-No.	EAN	Exterior H x W x D	Interior H x W x D	Weight	Volume
	40 03482...	mm	mm	kg	l
SMART 2E	22020 7	260 x 350 x 271	258 x 348 x 214	6,5	19,2



Basic 1E

Basic Safe 1E

- single-walled
- compact freestanding home safe
- re-programmable electronic lock
- emergency override lock

Art.-No.	EAN	Exterior H x W x D	Interior H x W x D	Weight	Volume
	40 03482...	mm	mm	kg	l
BASIC 1E	26780 6	200 x 310 x 203	198 x 308 x 143	4,5	8,7



Universal 2E

Universal Safe 2E

- single-walled
- compact freestanding home safe
- re-programmable electronic lock
- emergency override lock

Art.-No.	EAN	Exterior H x W x D	Interior H x W x D	Weight	Volume
	40 03482...	mm	mm	kg	l
UNI 2E	21040 6	260 x 350 x 268	258 x 348 x 212	6,4	19,0



Key Safes

KEY SAFE

- secure storage for keys and other valuables
- easy and controlled access for workmen, car rental, care personnel, tourists etc.
- very strong zinc die-cast body
- 4-digit, individually adjustable combination
- 10.000 resettable combinations
- '0-0-0-0' auto stop aids opening in poor light
- for wall mounting indoors or protected outdoor areas
- **KEY SAFE 10 SB:**
 - integrated key hook
 - maximum key length 7cm
- **KEY SAFE 20 SB:**
 - magnetic key ring holder
 - maximum key length 12cm



Key Safe 10 SB



Key Safe 20 SB

Art.-No.	EAN	W x H x D	Maximum key length
	40 03482...	mm	cm
Key Safe 10 SB	37990 5	61 x 85 x 39	7
Key Safe 20 SB	38000 0	83 x 135 x 46	12



Available from 3rd quarter of 2014



Key Safe 20 SB



Wall safes – Diplomat



WT 10/6 350 E



WT 10/6 580 E



Wall safes WT 10 'Diplomat'

RESISTANCE GRADE I

- type tested and supervised security by ECB-S
- back wall made of 10 mm strong steel construction with stainless steel proportion as flame-cutting protection; more security – less installation depth
- double-walled door, door leaf made of SM steel, thickness: 10mm
- manganese steel plating as additional protection of the lock
- three-sided locking through strong square bolts, bolts with 2 integrated steel rolls each, double protection against flame-cutting
- all-over rear gripping bar on the hinge side
- door with fire-protective material according to DIN 4102-A1
- body with specially designed fire fold
- available with interior safe suitable for file storage
- movable shelf (size 6 + 8 with 2 shelves)
- two-coloured
- **security advantage:** door with double emergency locking mechanism, not resettable, patented. Special protection against break-through prior to each bolt and in front of the lock.
- also available with left-sided hinge



Version E

Programmable electronic combination lock 'SecuTronic' with integrated fingerprint module, certified according to VdS class 2. With intelligent menu-driven operation. Administration of up to 10 user codes, up to 20 fingerprints and up to 300 optional TSE E-KEY. User names, access times and rights, calendar functions, etc. programmed via optional TSE PC software packages, incl. 2 batteries Mignon LR 6 AA. The locking armature protrudes 32 mm.

Art.-No.	EAN	Exterior H x W x D	Interior H x W x D	Door H x W	Weight	Volume
		mm	mm	Opening mm		
WT 10/5 350 E	21580 7	465 x 500 x 385	345 x 370 x 300	345 x 340	65	37,8
WT 10/6 350 E	21640 8	620 x 500 x 385	500 x 370 x 300	500 x 340	80	54,8
WT 10/6 580 E	21790 0	620 x 500 x 580	500 x 370 x 495	500 x 340	90	90,3
WT 10/8 350 E	21700 9	980 x 500 x 385	860 x 370 x 300	860 x 340	115	94,2
WT 10/8 580 E	21820 4	980 x 500 x 580	860 x 370 x 495	860 x 340	130	155,4
IT WT 10	09960 5	Interior safe for WT 10 for files (dimensions: H 180, W 370, D 260 mm)				

Optimal utilisation of the interior space

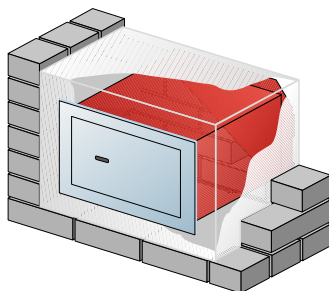
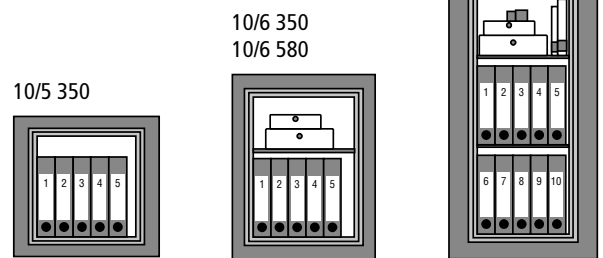

Reinforced back wall - therefore the whole thickness of the wall can be used - no concrete backwall necessary

BURG-WÄCHTER Security-Level

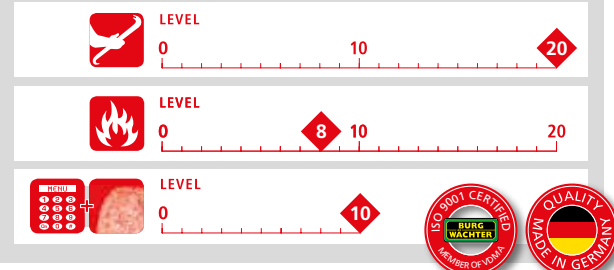

Wall safes – Karat



Wall safes WT 14 N - WT 16 N 'Karat'

RESISTANCE GRADE 0

- type tested and supervised security by ECB-S!
- the wall safe series with variable depth – optimal utilization of space through the adjustable body
- exterior frame of flame-cutting protected stainless steel material
- double walled door, with additional armouring, door leaf of 7 mm SM steel
- three-sided locking through square bolts, bolts on the top and on the bottom with integrated steel rolls – extreme protection against flame-cutting, drilling and attack, all-over gripping bar on the hinge side
- door with fire-protective material according to DIN 4102-A1
- body with specially designed fire fold
- sufficient space for files of common size when at maximum depth
- 1 movable shelf
- colour: dark grey
- **security advantage:** thermal emergency locking mechanism, puncture-proof plate in front of every bolt.



WT 14 N E



Version S

Resettable, armoured high-security safe lock 'SecuSafe', VdS tested ECB-S certified according to EN 1300 class B, 10 levers, key retaining, 50.000.000 key differs. More security in case of losing the key – immediately resettable to a new key. The locking armature protrudes 5 mm.
For detailed information on the resettable high security safe lock TRS 22 see p. 130.

Art.-No.	EAN	Exterior H x W x D mm	Interior H x W x D mm	Door H x W Opening mm	Weight kg	Volume l
WT 14 N S	28340 0	342 x 434 x 233 -351	250 x 352 x 178 -296	250 x 336	27,5	15,6 -26,0
WT 16 N S	28360 8	532 x 434 x 233 -351	440 x 352 x 178 -296	440 x 336	39,0	27,5 -45,7



Version E

Programmable electronic combination lock 'SecuTronic', VdS tested, ECB-S certified according to EN 1300 class B. With intelligent menu-driven operation. Up to 10 6-digit usercodes can be programmed and max. 300 optional TSE E-Keys. User names, access times and rights, calendar functions, etc. programmed via optional TSE PC software packages, incl. 2 batteries Mignon LR 6 AA. The locking armature protrudes 18 mm.

Art.-No.	EAN	Exterior H x W x D mm	Interior H x W x D mm	Door H x W Opening mm	Weight kg	Volume l
WT 14 N E	28350 9	342 x 434 x 233 -351	250 x 352 x 178 -296	250 x 336	27,5	15,6 -26,0
WT 16 N E	28380 6	532 x 434 x 233 -351	440 x 352 x 178 -296	440 x 336	39,0	27,5 -45,7



WT 16 N S



Version E FS

Programmable electronic combination lock 'SecuTronic' with integrated fingerprint-scan-module, certified according to VdS class 2. With intelligent menu-driven operation. Up to 10 6-digit usercodes can be programmed, up to 20 Fingerscans and max. 300 optional TSE E-Keys. User names, access times and rights, calendar functions, etc. programmed via optional TSE software packages, incl. 2 batteries Mignon LR 6 AA. The locking armature protrudes 32 mm.

Art.-No.	EAN	Exterior H x W x D mm	Interior H x W x D mm	Door H x W Opening mm	Weight kg	Volume l
WT 14 N E FS	32730 2	342 x 434 x 233 -351	250 x 352 x 178 -296	250 x 336	27,5	15,6 -26,0
WT 16 N E FS	32740 1	532 x 434 x 233 -351	440 x 352 x 178 -296	440 x 336	39,0	27,5 -45,7



WT 14 N E FS

BURG-WÄCHTER Security-Level

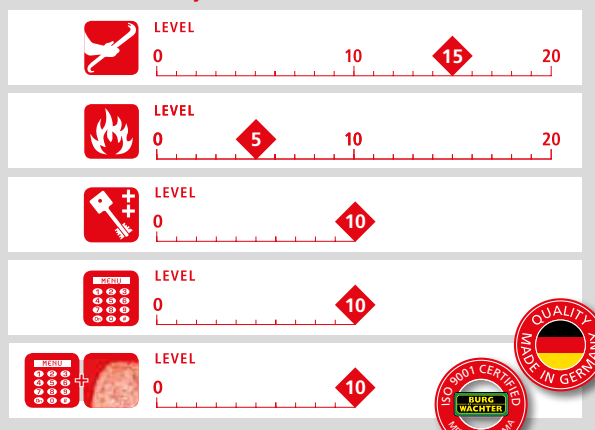

The best solution for maximising the interior space: Variable depth, adjustable safe body (see sketch on the right). Pull-out shelves adapt themselves individually to every depth (WT 14/16 for files of common size when at maximum depth).

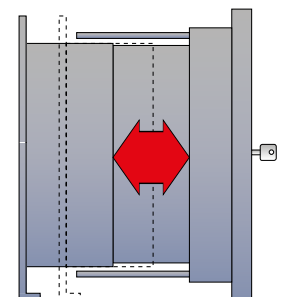

Tip: variable depth for optimal utilisation of the interior space according to the wall thickness



Wall safes – Karat



WT 12 S

Wall safes WT 11 - WT 13 'Karat'

SECURITY LEVEL B

- security level B according to VDMA 24992, 5/95
- the series of wall safes with variable depth – optimal utilisation of space through the adjustable body
- double walled door
- door leaf of 7 mm SM steel
- solid locking through square bolts



- all-over gripping bar on the hinge side
- door with fire-protective material according to DIN 4102-A1
- body with specially designed fire fold
- colour: dark grey



Version S

Armoured security safe lock 'SecuSafe', VdS tested; ECB-S certified according to EN 1300 class A, 9 levers, key captive, more than 1.000.000 key differs.

Art.-No.	EAN	Exterior H x W x D	Interior H x W x D	Door H x W	Weight	Volume
	40 03482...	mm	mm	Opening mm	kg	l
WT 11 S	27800 0	170 x 240 x 119 -163	110 x 190 x 74,5 -118,5	110 x 130	7,5	1,55 -2,4
WT 12 S	27810 9	205 x 290 x 119 -163	145 x 240 x 74,5 -118,5	145 x 190	10,2	2,6 -4,1
WT 13 S	27830 7	250 x 350 x 233 -351	190 x 300 x 188,5 -306,5	190 x 251	18,0	10,7 -17,4



Version E

Electronic combination lock 'SecuTronic', VdS tested; ECB-S certified according to EN 1300 class B. 1.000.000 different combinations possible. Incl. 3 batteries Micro LR 03 AAA. The locking armature protrudes 13 mm.

Art.-No.	EAN	Exterior H x W x D	Interior H x W x D	Door H x W	Weight	Volume
	40 03482...	mm	mm	Opening mm	kg	l
WT 13 E	27820 8	250 x 350 x 233 -351	190 x 300 x 188,5 -306,5	190 x 251	18,0	10,7 -17,4

BURG-WÄCHTER Security-Level



LEVEL



LEVEL



LEVEL



LEVEL



Important recommendations for built-in wall safes:

- after unpacking the safe, please check it is functioning perfectly prior to installation.
- for your own security remove all batteries from the front of the E-Version safes.
- to protect against any short-circuit damage due to humidity, or to prevent new coding by unauthorized persons, do not insert the batteries into the battery compartment until all works have finished and there is no humidity left in the area surrounding of the safe.
- prepare wall opening according to explanation mentioned below.
- wall opening has to be big enough so that the safe is surrounded with concrete of at least 100 mm on each side.
- protect the safe front with foil
- insert the safe in to the opening and prop it using wedges. (Ensure the door will fully open). Use a spirit level to make sure the safe is level.
- concrete class C35/45, mixture 1:4, put in and compress, mixture should not be too wet.
- open safe door after approx. 2 days after setting in concrete, wipe out any remaining moisture and let it dry.
- for security reasons safes and keys are not numbered. Spare keys can only be produced against presentation of a sample.
- safe locks should not be oiled.
- if you have a safe with combination lock you should keep you code a secret.

Please note:

Installation into exterior walls can cause condensation water due to temperature differences. In installations such as these, the safe should be insulated. Failures due to condensation water or improper installation are at owner's risk.

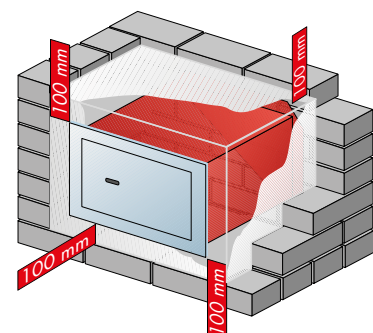



Wall safes – CityLine, PointSafe

Wall safe CityLine CW 5

SECURITY LEVEL B

- security level B according to VDMA 24992, 5/95
- double-walled door
- security double-bit key lock, VdS tested class 1; according to EN 1300 class A
- 9 levers



- more than 1.000.000 key differs
- locking through round bolts
- door with fire-protective material according to DIN 4102-A1
- specially designed fire fold
- sufficient space for files of common size



Version S

Armoured security safe lock 'SecuSafe', VdS tested; ECB-S certified according to EN 1300 class A, 9 levers, 1.000.000 key differs.



CW 5 350 S

Art.-No.	EAN	Exterior H x W x D	Interior H x W x D	Door H x W	Weight	Volume
	40 03482...	mm	mm	Opening mm	kg	l
CW 5 350 S	15030 6	326 x 440 x 350	243 x 343 x 294	243 x 335	19,5	24,5

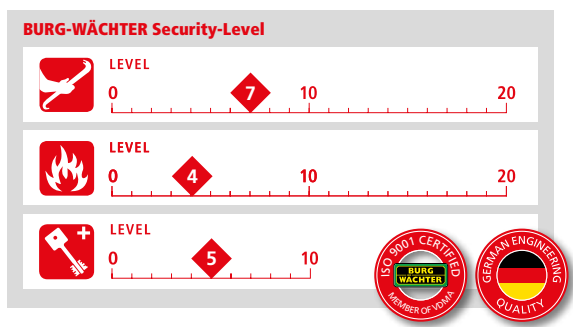

Wall safes PointSafe PW 1 - PW 3

- tested in the BURG-WÄCHTER laboratory
- solid single-walled body



Version S

Security safe lock, with 2 keys



PW 1 S

Art.-No.	EAN	Exterior H x W x D	Interior H x W x D	Weight	Volume
	40 03482...	mm	mm	kg	l
PW 1 S	24900 0	180 x 260 x 148	150 x 230 x 100	6,8	3,5
PW 2 S	24860 7	220 x 340 x 140	177 x 298 x 85	10,2	4,5
PW 3 S	24870 6	260 x 390 x 195	213 x 345 x 140	15,0	10,3



Version E

Electronic combination lock with user programmed master, and user codes. User code can be changed at any time. Smooth motor powered locking mechanism automatically opens the door. No electrical supply necessary, 4 x Mignon LR6 AA batteries included. Also has mechanical emergency over-ride lock. The locking armature protrudes 13mm.



PW 2 S

Art.-No.	EAN	Exterior H x W x D	Interior H x W x D	Weight	Volume
	40 03482...	mm	mm	kg	l
PW 2 E	24960 4	220 x 340 x 140	177 x 298 x 85	10,2	4,5
PW 3 E	24970 3	260 x 390 x 195	213 x 345 x 140	14,8	10,3

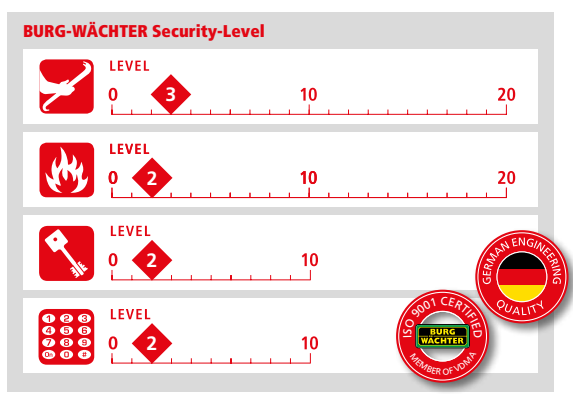

PW 3 E



**BURG
WÄCHTER**

Gun cabinets – Ranger S1



Ranger R S1/5 S

Ranger R S1/5

**RESISTANCE GRADE S1
RESISTANCE GRADE A**

Single-walled gun cabinet with lockable compartment

- type tested and supervised security, resistance grade S1 according to EN 14450
- for up to 5 rifles
- maximum clear height 1250 mm
- single-walled body made of 3 mm steel with specially designed fire fold
- double-walled door
- three-sided locking through strong round bolts
- with holder for barrel cleaners in the door
- with lockable compartment (H 143, W 293, D 220 mm inside)
- prepared for wall and floor fixing, including fixing material
- German Technology
- colour: black (similar to RAL 9005)



Version S

Armoured security safe lock 'SecuSafe', VdS tested, ECB-S certified according to EN 1300 class A, 9 levers, more than 1.000.000 key differs. The locking armature protrudes 20 mm.

Art.-No.	EAN	for rifles	Exterior H x W x D	Interior H x W x D	Weight
	40 03482...		mm	mm	kg
Ranger R S1/5 S	32950 4	5	1450 x 300 x 315	1444 x 294 x 265	63



Ranger R S1/5 E



Version E FS

Electronic combination lock 'SecuTronic', with integrated fingerscan module, VdS approved class 2. With intelligent menu-driven operation, administration of up to 10 user codes, up to 20 fingerscans and up to 300 optional TSE E-KEY. User names, access times and -rights, calendar functions, etc. programmed via optional TSE software packages. Incl. 2 batteries Mignon LR 6 AA. The locking armature protrudes 40 mm.

Art.-No.	EAN	for rifles	Exterior H x W x D	Interior H x W x D	Weight
	40 03482...		mm	mm	kg
Ranger R S1/5 E	32960 3	5	1450 x 300 x 315	1444 x 294 x 265	63

SecuTronic – the first biometric safe lock with VdS certification. Developed by BURG-WÄCHTER.

- VdS approved safe lock with fingerscan module, EN 1300 class 2
- programmable electronic combination lock
- in addition to ten 6 digit user programmed codes, 20 fingers can also be programmed
- when opening with fingerscan, two fingerscans, or one fingerscan and one code must be used
- 1.000.000 combinations possible
- the scanner only works with 'real, live, fingers'. Fake fingers or copies will not be identified
- the precise and highly sensitive procedure of authentication operates with different dermal conditions, from extremely dry to more humid skin
- the opening of a safe by using the fingerscan is very quick and comfortable



Currently the only certified safe lock with fingerscan module



Ranger R S1/5



According to § 36 of the current German law on arms, 04/2009. BURG-WÄCHTER recommends the Ranger I/8 gun safes for the safe keeping of **handguns and ammunition.**

Gun cabinets – Ranger S1



Ranger R S1/7

**RESISTANCE GRADE S1 / Interior compartment RESISTANCE GRADE B
RESISTANCE GRADE A**

Single-walled gun cabinet with lockable compartment

- type tested and supervised security, resistance grade S1 according to EN 14450
- for up to 7 rifles
- maximum clear height 1220 mm
- single-walled body made of 3 mm steel with specially designed fire fold
- double-walled door
- three-sided locking through strong round bolts
- with holder for barrel cleaners in the door
- **lockable interior compartment, double-walled** e. g. for common ammunition storage (H 110, W 270, D 155 mm inside), security grade B according to the VDMA 24992 – 5/95
- prepared for wall and floor fixing, fixings included
- German Technology
- colour: black (similar to RAL 9005)



Version S

Armoured security safe lock 'SecuSafe', VdS tested, ECB-S certified according to EN 1300 class A, 9 levers, more than 1.000.000 key differs. The locking armature protrudes 20 mm.

Art.-No.	EAN	for rifles	Exterior H x W x D	Interior H x W x D	Weight
	40 03482...		mm	mm	kg
Ranger R S1/7 S	32970 2	7	1450 x 400 x 315	1444 x 394 x 265	82



Version E FS

Electronic combination lock 'SecuTronic', with integrated fingerscan module, VdS approved class 2. With intelligent menu-driven operation, administration of up to 10 user codes, up to 20 fingerscans and up to 300 optional TSE E-KEY. User names, access times and rights, calendar functions, etc. programmed via optional TSE software packages. Incl. 2 batteries Mignon LR 6 AA. The locking armature protrudes 40 mm.

Art.-No.	EAN	for rifles	Exterior H x W x D	Interior H x W x D	Weight
	40 03482...		mm	mm	kg
Ranger R S1/7 E	32980 1	7	1450 x 400 x 315	1444 x 394 x 265	82



Ranger R S1/7 E



SecuTronic - the first biometric safe lock with VdS certification.

These gun cabinets represent BURG-WÄCHTER's reaction to current considerations that arms should only be stored in cabinets with biometric locks.

Biometric locking systems with fingerscan exclude the key-risk and make every opening traceable.

The lock installed in our Ranger gun cabinets was the first biometric lock with VdS certification (October 2010).

Moreover the gun cabinet Ranger was the first one of its product class to be certified according to ECBS security grade S1.



Ranger R S1/7

BURG-WÄCHTER safes correspond to the highest state-of-the-art technology and are internationally recognized. BURG-WÄCHTER is member of the VDMA security systems association and European Security Systems Association (ESSA e. V.). Changes in dimensions and constructions of wall safes and freestanding home safes can occur due to technical production changes.



Gun cabinets – Ranger I



Ranger I/8

Ranger I/8

RESISTANCE GRADE I

- type tested and supervised security by the ECB-S/VdS
- protection against burglary and fire
- clear height with inserted shelf: 1241 mm
- body double-walled
- door double-walled
- solid 3-sided locking through round bolts of Ø 28 mm
- clear height up to the inserted shelf: 1220 mm
- additional round bolts on the hinge side
- prepared for floor fixing, with fixing material
- conforms to § 36 of the current German law on arms (April 2009)
- **security advantage:** includes non-resettable emergency locking system within the door mechanics



Version S

Resettable, armoured high-security safe lock, 'SecuSafe', ECB-S certified according to EN 1300 class B, with 2 keys, 10 levers, key retaining, 50.000.000 key differs. More security in case of losing the key – immediately resettable to a new key. The locking armature protrudes 25 mm.

For detailed information on the resettable high security safe lock SecuSafe see p. 130.

Art.-No.	EAN	for rifles	Exterior H x W x D	Interior H x W x D	Weight
	40 03482...		mm	mm	kg
Ranger I/8 S	32260 4	8	1486 x 641 x 554	1336 x 498 x 370	265



Version E

Electronic combination lock 'SecuTronic', VdS tested, ECB-S certified according to EN 1300 class B, 1.000.000 different combinations possible, incl. 3 batteries Mignon LR6 AA. The locking armature protrudes 50 mm.

Art.-No.	EAN	for rifles	Exterior H x W x D	Interior H x W x D	Weight
	40 03482...		mm	mm	kg
Ranger I/8 E	32270 3	8	1486 x 641 x 554	1336 x 498 x 370	265



Ranger I/8 S



Ranger I/8 S

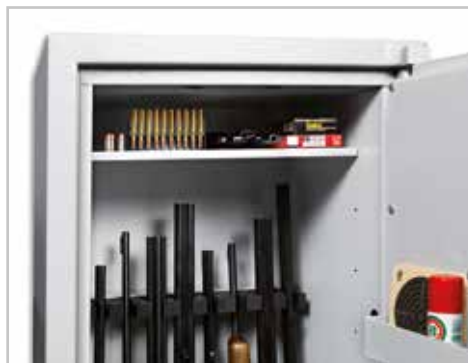

Tip:
Effective additional protection for arms:
BURG-WÄCHTER Gun Lock, see page 32!



According to § 36 of the current German law on arms, 04/2009. BURG-WÄCHTER recommends the Ranger I/8 gun safes for the safe keeping of **handguns and ammunition**.



Ranger I/8 E

BURG-WÄCHTER safes correspond to the highest state-of-the-art technology and are internationally recognized. BURG-WÄCHTER is member of the VDMA security systems association and European Security Systems Association (ESSA e. V.). Changes in dimensions and constructions of wall safes and freestanding home safes can occur due to technical production changes.

Gun cabinets – Ranger A and AB



Ranger A 5

SECURITY LEVEL A

Single-walled gun cabinet for 5 rifles

- security level A according to VDMA 24992, 5/95
- double-walled door, Thickness of door 55mm
- body of 3 mm steel with specially designed fire fold
- three-sided locking through strong round bolts
- clear height: 1250 mm
- the hinges protrude 20 mm
- holder for cleaning rod on the door
- prepared for wall and floor fixing
- with lockable interior safe (H 143, W 293, D 232mm interior)
- high-quality workmanship
- German Technology
- conforms to § 36 of the current German law on arms (April 2009)
- colour: black (similar to RAL 9004)



Version S

Armoured security double bit key lock 'SecuSafe' - VdS tested; ECB-S certified according to EN 1300 class A, 9 levers, 1 million key differs. The hinges protrude 20 mm.

Art.-No.	EAN	for rifles	Exterior H x W x D	Interior H x W x D	Weight
	40 03482...		mm	mm	
A 5 S	02970 1	5	1450 x 300 x 335	1444 x 294 x 265	64



Version E

Electronic combination lock 'SecuTronic', VdS tested; ECB-S certified according to EN 1300 class B. 1.000.000 different combinations possible. Incl. 3 batteries Micro LR 03 AAA. The locking armature protrudes 13 mm. The hinges protrude 20 mm.

Art.-No.	EAN	for rifles	Exterior H x W x D	Interior H x W x D	Weight
	40 03482...		mm	mm	
A 5 E	34250 3	5	1450 x 300 x 335	1444 x 294 x 265	64



Ranger A 5

Ranger W 7 A/B

SECURITY LEVEL A / Interior compartment SECURITY LEVEL B

Single-walled gun cabinet for 7 rifles

- security level A according to VDMA 24992, 5/95
- double-walled door, thickness of door 55mm
- body of 3 mm steel with specially designed fire fold
- three-sided locking through strong round bolts
- clear height: 1220 mm
- the hinges protrude 20 mm
- holder for cleaning rod on the door
- prepared for wall and floor fixing
- lockable interior compartment, double-walled (H 110, W 274, D 165 mm interior)
- security grade B according to the VDMA 24992 - 5/95
- high-quality workmanship - protection against small fire
- German Technology
- conforms to § 36 of the current German law on arms (April 2009)
- colour: black (similar to RAL 9004)



Version S

Armoured security double-bit lock 'SecuSafe' - VdS tested; ECB-S certified according to EN 1300 class A, 9 levers, 1 million key differs. The hinges protrude 20 mm.

Art.-No.	EAN	for rifles	Exterior H x W x D	Interior H x W x D	Weight
	40 03482...		mm	mm	
W 7 A/B S	29980 7	7	1450 x 400 x 335	1444 x 394 x 265	76



Version E

Electronic combination lock 'SecuTronic', VdS tested; ECB-S certified according to EN 1300 class B. 1.000.000 different combinations possible. Incl. 3 batteries Micro LR 03 AAA. The locking armature protrudes 13 mm. The hinges protrude 20 mm.

Art.-No.	EAN	for rifles	Exterior H x W x D	Interior H x W x D	Weight
	40 03482...		mm	mm	
W 7 A/B E	34260 2	7	1450 x 400 x 335	1444 x 394 x 265	76



Ranger W 7 A/B

Key blank for Ranger A 5, W 7 A/B

Key	EAN	
	40 03482...	
As per sample	16620 8	Length of key 68 mm
Key blank 51	16670 3	Key blank, PU 3 pcs.



High Quality Commercial Safes – Royal



E 514 ES
Special painting
Photo for information only

Security characteristics of the series ROYAL

- type tested and supervised security by ECB-S
- body triple-walled
- concealed hinges
- three-sided locking through strong round bolts, multiple mounted (Royal E 512 - E 548)
- three-sided locking through strong square bolts with broad blocking surface, multiple mounted (Royal E 552 - E 558)
- armoured bolt system
- all-over gripping bar on the hinge side
- locking mechanism with special protection against penetration
- the locking armature handle protrudes 65 mm
- fire protective material according to DIN 4102
- specially designed fire fold
- prepared for quadro wall fixing, fixings included
- interior with sufficient space for files of common size

Special equipment available as optional extras:

- removable shelf as standard, **individual interior equipment, please see p. 151**
- standard painting: grey/white **individual special finish in RAL and/or brilliant see page 151**
- recommendation for more security: combine two locking systems with each other
- wide range of **locking systems, go to p. 150.**



High Quality Commercial Safes ROYAL E 512 - 518

RESISTANCE GRADE I

Standard locking system:

- resettable, armoured high-security safe lock 'SecuSafe', ECB-S certified according to EN 1300 class B
- more security in case of losing the key – immediately resettable to a new key
- 10 levers, key captive
- 50.000.000 key differs



E 522 E

Art.-No.	EAN	Exterior H x W x D mm	Interior H x W x D mm	Bolts	Weight kg	Volume l
E 512 S	25400 4	1000 x 695 x 635	745 x 545 x 400	8 ①	220	162
E 514 S	25500 1	1315 x 695 x 635	1060 x 545 x 400	12 ①	305	231
E 516 S	25600 8	1755 x 695 x 635	1500 x 545 x 400	14 ①	350	327
E 518 S	20740 6	1755 x 1130 x 635	1500 x 980 x 400	18 ①	500	588

① = round bolt



E 512 - E 518 with electronic combination lock
Fingerscan module as standard.



High Quality Commercial Safes ROYAL E 522 - 528

RESISTANCE GRADE II

Standard locking system:

- resettable, armoured high-security safe lock 'SecuSafe', ECB-S certified according to EN 1300 class B
- more security in case of losing the key – immediately resettable to a new key
- 10 levers, key retaining
- 50.000.000 key differs

More security:

- isolating material according to DIN 4102
- emergency locking mechanism, not resettable

Art.-No.	EAN	Exterior H x W x D mm	Interior H x W x D mm	Bolts	Weight kg	Volume l
E 522 S	25900 9	1000 x 695 x 635	745 x 545 x 400	8 ①	360	162
E 524 S	26000 5	1315 x 695 x 635	1060 x 545 x 400	12 ①	480	231
E 526 S	26100 2	1755 x 695 x 635	1500 x 545 x 400	14 ①	640	327
E 528 S	20950 9	1755 x 1130 x 635	1500 x 980 x 400	18 ①	910	588

① = round bolt



E 522 - E 528 with electronic combination lock
Fingerscan module as standard.

The BURG-WÄCHTER safes of this series comply to the specifications of the European norm EN 1143-1 and/or EN 1047-1. This is approved by the **ECB-S** certificates of the European Certification Board • Security systems (Certification authorities according to EN 45001). The **ECB-S** certification includes multiple unannounced inspections of the production sites. Hereby a constant quality level is guaranteed. Errors and omissions excepted.



Armoured safes – Royal



High Quality Commercial Safes ROYAL E 532 - 538

RESISTANCE GRADE III



Standard locking system:

- resettable, armoured high-security twin tumbler lock, 'SecuSafe', ECB-S certified according to EN 1300 class B
- more security in case of losing the key – immediately resettable to a new key
- 10 levers, key retaining
- 50.000.000 key differs

More security:

- fire-protective material (special armour-mass) according to DIN 4102
- emergency locking mechanism, not resettable

Art.-No.	EAN	Exterior H x W x D	Interior H x W x D	Bolts	Weight	Volume
	40 03482...	mm	mm		kg	l
E 532 S	26400 3	1000 x 695 x 635	745 x 545 x 400	8	540	162
E 534 S	26500 0	1315 x 695 x 635	1060 x 545 x 400	12	690	231
E 536 S	26600 7	1755 x 695 x 635	1500 x 545 x 400	14	900	327
E 538 S	21830 3	1755 x 1130 x 635	1500 x 980 x 400	18	1280	588

= round bolt



E 532 - E 538 with electronic combination lock
Fingerscan module as standard.



E 532 E,
special paint brilliant blue

High Quality Commercial Safes ROYAL E 542 - 548

RESISTANCE GRADE IV



Standard locking system:

- two resettable, armoured high-security twin tumbler locks, 'SecuSafe', ECB-S certified according to EN 1300 class B
- more security in case of losing the key – immediately resettable to a new key
- 10 levers, key retaining
- 50.000.000 key differs

More security:

- fire-protective material (special armour-mass) according to DIN 4102
- double emergency locking mechanism, not resettable
- generally with 2 locking systems

Art.-No.	EAN	Exterior H x W x D	Interior H x W x D	Bolts	Weight	Volume
	40 03482...	mm	mm		kg	l
E 542 SS	26900 8	1000 x 695 x 635	745 x 545 x 400	6 + 1	560	162
E 544 SS	27000 4	1315 x 695 x 635	1060 x 545 x 400	10 + 1	720	231
E 546 SS	27100 1	1755 x 695 x 635	1500 x 545 x 400	12 + 1	940	327
E 548 SS	23090 9	1755 x 1130 x 635	1500 x 980 x 400	14 + 2	1340	588

= round bolt / = square bolt



E 544 ES

High Quality Commercial Safes ROYAL E 552 - 558

RESISTANCE GRADE V



Standard locking system:

- two resettable, armoured high-security twin tumbler locks, 'SecuSafe', ECB-S certified according to EN 1300 class B
- more security in case of losing the key – immediately resettable to a new key
- 10 levers, key retaining
- each with 50.000 key differs

More security:

- fire-protective material (special armour-mass) according to DIN 4102-A1
- double emergency locking mechanism, not resettable
- generally with 2 locking systems
- additional armoured in front of and behind the locking system
- special double armoured in body and door
- double basquill lock at the top and at the bottom

Art.-No.	EAN	Exterior H x W x D	Interior H x W x D	Bolts	Weight	Volume
	40 03482...	mm	mm		kg	l
E 552 SS	24550 7	1040 x 735 x 680	745 x 545 x 400	6	980	162
E 554 SS	24600 9	1355 x 735 x 680	1060 x 545 x 400	8	1250	231
E 556 SS	25090 7	1795 x 735 x 680	1500 x 545 x 400	9	1650	327
E 558 SS	25470 7	1795 x 1170 x 680	1500 x 980 x 400	9	2300	588

= square bolt



ROYAL Locking systems, Extension grades

Locking systems for ROYAL according to VdS Safelock listing 2323

Version	Lock class	Description
EN 1300		
Series E 512 - 538:		
S	B	1 high-security safe lock, standard fitting
SS	B	2 high-security safe locks
C	B	1 manipulation-protected, resettable combination lock instead of the safe lock
CS	B	1 manipulation-protected, resettable combination lock and a high-security safe lock
CC	B	2 manipulation-protected, resettable combination locks
E*	B	1 electronic combination lock instead of the high-security safe lock
ES*	B	1 electronic combination lock and a safe lock
EE*	B	2 electronic combination locks
Series E 542 - 558:		
SS	B	2 high-security safe locks as standard
CS	B	1 manipulation-protected, resettable combination lock and a high-security safe lock
ER S	B	1 redundant electronic combination lock and 1 high-security safe lock
ER ER	B	2 redundant electronic combination locks
High-tech locking systems for much more security:		
HSS	C	2 high-security safe locks



Version S



Version SS



Version C



Version CS



Version CC



Version E



Version ES



Version EE



Version HSS

* Safes ROYAL E 512 - 538 with electronic combination lock 'SecuTronic', Fingerscan module as standard:

Programmable electronic combination lock 'SecuTronic' with integrated fingerscan module, certified according to VdS class 2. Intelligent user guidance. Up to 10 six-digit usercodes programmable, up to 20 fingerprints and max. 300 optional TSE E-Keys. The optional TSE Software offers functions like user administration, definition of time frames and authorisations, history reports, etc. Incl. 2 Batteries Mignon LR 6AA.



Version ES



Version E



Version EE

Key sets for Royal

Detailed information on the resettable high security safe lock 'SecuSafe' see p. 130.

Key	EAN	
	40 03482...	
Set 55 GLK-2	09270 5	two key set, length: 162 mm, incl. hinge
Set 55 GLK-4	09290 3	four key set, length: 162 mm, incl. hinge
Set 55 GLK-6	06900 4	six key set, length: 162 mm, incl. hinge
As per sample	08790 9	lock class B, length: 162 mm, incl. hinge
Safe key as per sample		
for models 540 - 558	12020 0	with hinge, lock class C



Accessories, Special versions Royal

Special paintwork on request

Paintwork/Size	Paintwork/Size
RAL, Size 2	Brillant, Size 2
RAL, Size 4	Brillant, Size 4
RAL, Size 6	Brillant, Size 6
RAL, Size 8	Brillant, Size 8

Brilliant paintwork: for accessories (interior safe, etc.)

Special fittings on request

Description
Bolt and handle gold-plated
Bolt and handle and 1 armature gold-plated (except E)
Bolt and handle and 2 armatures gold-plated (except E)
Handle chromium-plated or varnished
Handle and 1 armature chromium-plated or varnished
Handle and 2 armatures chromium-plated or varnished
Front panel with RAL paintwork
Front panel with brilliant paintwork
Front panel gold- chromium- or brass-plated

Accessories ROYAL E 512 - 558

Art.-No.	EAN	Description
	40 03482...	
		for ROYAL sizes 2 - 6:
IT 1 ZS monté	15240 9	Interior safe with cylinder lock – 250 mm high (inside 210 mm)
IT 2 TR monté	15250 8	Interior safe with safe lock – 405 mm high (inside 365 mm for files)
FB 36	15350 5	Additional shelf
A-FB 510	15360 4	Pull-out shelf
A-HR 510	15370 3	Telescopic pull-out hanging frame
		for ROYAL size 8:
IT 2 TR monté	15250 8	Interior safe with twin tumbler lock – 405 mm high (inside 365 mm)
FB 37	07460 2	Additional shelf
A-FB 517	05190 0	Pull-out shelf
A-HR 517	05180 1	Telescopic pull-out hanging frame



Interior safe IT 1



Interior safe IT 2



A-HR 510

High Quality Commercial Safes ROYAL sizes 2 - 8



size 2

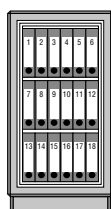

size 4

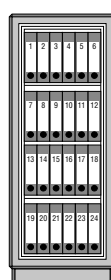

size 6

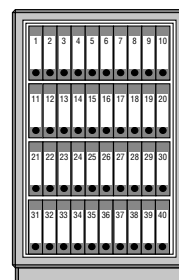

size 8

Examples for the individual utilisation of the interior space

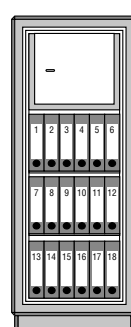
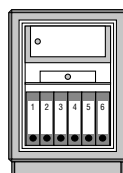
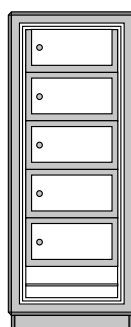
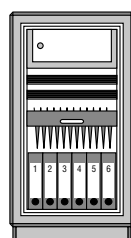
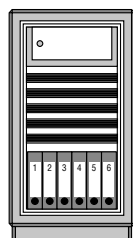

Special solutions for professional demands: Ask our safe specialists for the perfect solution of your security demands.

Office Line 101 - 106

SECURITY LEVEL B

- safety cabinet/commercial freestanding safe
- security level B according to VDMA 24992, 5/95
- body double-walled
- door double-walled
- solid three-sided locking through round bolts of 28 mm Ø, additional round dog bolts on hinge side



- serially prepared for floor fixing, with fixing material, 1 centrally arranged drill hole on the bottom
- depth for files of common size, adjustable shelves, also available with interior safe
- standard series version painted light grey RAL 7035, armature black



Version S

Resettable, armoured high-security safe lock, 'SecuSafe', ECB-S certified according to EN 1300 class B, with 2 keys, 10 levers, key retaining, 50.000.000 key differs. The locking armature protrudes 25 mm. More security in case of losing the key – immediately resettable to a new key.

For detailed information on the resettable high security safe lock SecuSafe see p. 130.

Art.-No.	EAN	Exterior H x W x D	Interior H x W x D	Door H x W	Weight	Volume
	40 03482...	mm	mm	Opening mm	kg	l
Office 101 S	30610 9	626 x 641 x 554	476 x 498 x 370	476 x 498	110	87
Office 102 S	30630 7	816 x 641 x 554	666 x 498 x 370	666 x 498	126	122
Office 102 S 300	30850 9	816 x 641 x 554	666 x 498 x 370	666 x 498	300	122
Office 104 S	30650 5	1096 x 641 x 554	946 x 498 x 370	946 x 498	163	174
Office 104 S 300	30870 7	1096 x 641 x 554	946 x 498 x 370	946 x 498	300	174
Office 106 S	30840 0	1486 x 780 x 554	1336 x 638 x 370	1336 x 638	300	315



Version E

Electronic combination lock 'SecuTronic', ECB-S certified according to EN 1300 class B, 1.000.000 different combinations possible, incl. 3 batteries (Micro LR 03 AAA). The locking armature protrudes 50 mm.

Art.-No.	EAN	Exterior H x W x D	Interior H x W x D	Door H x W	Weight	Volume
	40 03482...	mm	mm	Opening mm	kg	l
Office 101 E	30600 0	626 x 641 x 554	476 x 498 x 370	476 x 498	110	87
Office 102 E	30620 8	816 x 641 x 554	666 x 498 x 370	666 x 498	126	122
Office 102 E 300	30860 8	816 x 641 x 554	666 x 498 x 370	666 x 498	300	122
Office 104 E	30640 6	1096 x 641 x 554	946 x 498 x 370	946 x 498	163	174
Office 104 E 300	30880 6	1096 x 641 x 554	946 x 498 x 370	946 x 498	300	174
Office 106 E	30890 5	1486 x 780 x 554	1336 x 638 x 370	1336 x 638	300	315

Interior safe for Office 101 - 106

It is also possible to assemble various interior safes (interior depth 290 mm) one below the other.

Art.-No.	EAN	suitable for:	H x W x D
	40 03482...		mm
IT - Office 1	15230 0	Office 101 -104/300	151 x 498 x 303
IT - Office 2	15320 8	Office 106	151 x 638 x 303

Practical accessories for Office 101 - 104

Art.-No.	EAN	suitable for:	
	40 03482...		
A-FB 100	04540 4	Office 101 -104/300	pull-out shelf Office
A-HR 100	04680 7	Office 101 -104/300	pull-out hanging frame Office

Key sets for OL 101-126 and MTD 34 F60-38 F60 S

Detailed information regarding the resettable high security safe lock SecuSafe see p. 130.

Key set	EAN	
	40 03482...	
Set 55-124-2	08920 0	two key set, length: 124 mm
Set 55-124-4	09260 6	four key set, length: 124 mm
Set 55-124-6	06890 8	six key set, length: 124 mm
As per sample	08780 0	Lock class B, Length of key 124 mm

Concerns door dimensions H x W:
headroom door opening in mm



Office 101 S



Office 102 E

The BURG-WÄCHTER safes of this series comply to the specifications of the European norm EN 1143-1 and/or EN 1047-1. This is approved by the ECB•S certificates of the European Certification Board • Security systems (Certification authorities according to EN 45001). The ECB•S certification includes multiple unannounced inspections of the production sites. Hereby a constant quality level is guaranteed. Errors and omissions excepted.



Safety cabinets – OfficeLine



Office Line 111 - 116

RESISTANCE GRADE I



- freestanding safety cabinet/ commercial freestanding safe
- type tested and supervised security by ECB-S!
- protected against burglary and fire
- body double-walled
- door double-walled
- solid three-sided locking through round bolts of 28 mm Ø, additional round dog bolts on hinge side

- prepared for floor fixing with fixing material. 1 centrally arranged drill hole on the bottom
- depth for files of common size, adjustable shelves, also available with interior safe
- standard series version painted light grey RAL 7035, black front blind



More security:

- non-resettable emergency re-locking mechanism within the door mechanics



Office 112 S



Version S

Resettable, armoured high-security safe lock, 'SecuSafe', ECB-S certified according to EN 1300 class B, with 2 keys, 10 levers, key retaining, 50.000.000 key differs. The locking armature protrudes 25 mm. More security in case of losing the key – immediately resettable to a new key.

For detailed information on the resettable high security safe lock SecuSafe see p. 130.

Art.-No.	EAN	Exterior H x W x D	Interior H x W x D	Door H x W	Weight	Volume
	40 03482...	mm	mm	Opening mm	kg	l
Office 111 S	30670 3	626 x 641 x 554	476 x 498 x 370	476 x 498	121	87
Office 112 S	30690 1	816 x 641 x 554	666 x 498 x 370	666 x 498	205	122
Office 114 S	30710 6	1096 x 641 x 554	946 x 498 x 370	946 x 498	213	174
Office 114 S 300	30790 8	1096 x 641 x 554	946 x 498 x 370	946 x 498	305	174
Office 116 S	30930 8	1486 x 780 x 554	1336 x 638 x 370	1336 x 638	310	315



Version E

Electronic combination lock 'SecuTronic', with integrated fingerscan module, VdS approved class 2. With intelligent menu-driven operation, administration of up to 10 user codes, up to 20 fingerscans and up to 300 optional TSE E-KEY.

User names, access times and rights, calendar functions, etc. programmed via optional TSE software packages. Incl. 2 batteries Mignon LR 6 AA.

The locking armature protrudes 50 mm.

Art.-No.	EAN	Exterior H x W x D	Interior H x W x D	Door H x W	Weight	Volume
	40 03482...	mm	mm	Opening mm	kg	l
Office 111 E	30660 4	626 x 641 x 554	476 x 498 x 370	476 x 498	121	87
Office 112 E	30680 2	816 x 641 x 554	666 x 498 x 370	666 x 498	205	122
Office 114 E	30700 7	1096 x 641 x 554	946 x 498 x 370	946 x 498	213	174
Office 114 E 300	30780 9	1096 x 641 x 554	946 x 498 x 370	946 x 498	305	174
Office 116 E	30940 7	1486 x 780 x 554	1336 x 638 x 370	1336 x 638	310	315



Office 114 E

Interior safe for Office 111 - 116

It is also possible to assemble various interior safes (interior depth 290 mm) – one below the other.

Art.-No.	EAN	suitable for:	H x W x D
	40 03482...		mm
IT - Office 1	15230 0	Office 111 -114/300	151 x 498 x 303
IT - Office 2	15320 8	Office 116	151 x 638 x 303

Practical accessories for Office 111 - 114

Art.-No.	EAN	suitable for:	
	40 03482...		
A-FB 100	04540 4	Office 111 -114/300	pull-out shelf Office
A-HR 100	04680 7	Office 111 -114/300	pull-out hanging frame Office

Technical modifications are planned for the further production series.

Optimal utilisation of the interior space of the Office Line series:

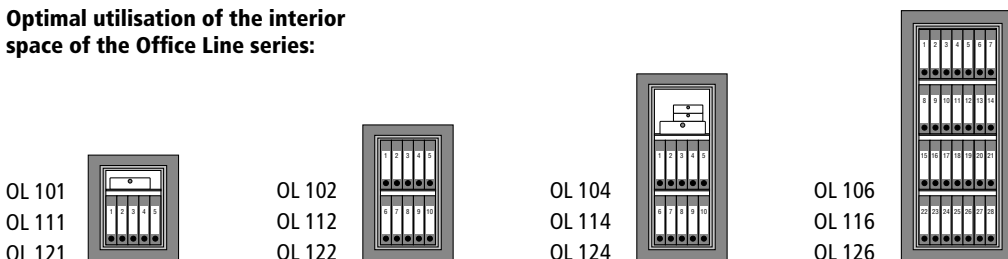

- OL 101
- OL 111
- OL 121

- OL 102
- OL 112
- OL 122

- OL 104
- OL 114
- OL 124

- OL 106
- OL 116
- OL 126



Safety cabinets – OfficeLine

Office Line 121 - 126

RESISTANCE GRADE II



- freestanding safety cabinet/commercial freestanding safe
- type tested and supervised security by ECB-S!
- protected against burglary and fire
- body double-walled
- door double-walled
- solid three-sided locking through round bolts of 28 mm Ø, additional round dog bolts on hinge side

- prepared for floor fixing with fixing material, 1 centrally arranged drill hole on the bottom
- depth for files of common size, adjustable shelves, also available with interior safe
- standard series version painted light grey RAL 7035, armature black



More security:

- non-resettable double emergency re-locking mechanism within the door mechanics



Office 121 S



Version S

Resettable, armoured high-security safe lock, 'SecuSafe', ECB-S certified according to EN 1300 class B, with 2 keys, 10 levers, key retaining, 50.000.000 key differs. The locking armature protrudes 25 mm. More security in case of losing the key – immediately resettable to a new key.

For detailed information on the resettable high security safe lock SecuSafe see p. 130.

Art.-No.	EAN	Exterior H x W x D	Interior H x W x D	Door H x W	Weight	Volume
	40 03482...	mm	mm	Opening mm	kg	l
Office 121 S	30020 6	626 x 641 x 554	476 x 498 x 370	476 x 498	205	87
Office 122 S	30040 4	816 x 641 x 554	666 x 498 x 370	666 x 498	205	122
Office 124 S	30060 2	1096 x 641 x 554	946 x 498 x 370	946 x 498	239	174
Office 126 S	30080 0	1486 x 780 x 554	1336 x 638 x 370	1336 x 638	336	315



Office 122 E



Version E

Electronic combination lock 'SecuTronic', with integrated fingerscan module, VdS approved class 2. With intelligent menu-driven operation, administration of up to 10 user codes, up to 20 fingerscans and up to 300 optional TSE E-KEY. User names, access times and rights, calendar functions, etc. programmed via optional TSE software packages. Incl. 2 batteries Mignon LR 6 AA. The locking armature protrudes 50 mm.

Art.-No.	EAN	Exterior H x W x D	Interior H x W x D	Door H x W	Weight	Volume
	40 03482...	mm	mm	Opening mm	kg	l
Office 121 E	30030 5	626 x 641 x 554	476 x 498 x 370	476 x 498	205	87
Office 122 E	30050 3	816 x 641 x 554	666 x 498 x 370	666 x 498	205	122
Office 124 E	30070 1	1096 x 641 x 554	946 x 498 x 370	946 x 498	239	174
Office 126 E	30090 9	1486 x 780 x 554	1336 x 638 x 370	1336 x 638	336	315

Interior safe for Office 121 - 126

It is also possible to assemble various interior safes (interior depth 290 mm) one below the other.

Art.-No.	EAN	suitable for:	H x W x D
	40 03482...		mm
IT - Office 1	15230 0	Office 121 - 124	151 x 498 x 303
IT - Office 2	15320 8	Office 126	151 x 638 x 303

Practical accessories for Office 121 - 124

Art.-No.	EAN	suitable for:
	40 03482...	
A-FB 100	04540 4	Office 121 - 124 pull-out shelf Office
A-HR 100	04680 7	Office 121 - 124 pull-out hanging frame Office



Office 126 E



Key safes

The safety cabinets OfficeLine 104, 114 and 124 can be equipped as key safes on demand.

The interior contains 480 hooks fixed on 3 solid and free-moving completely extractable telescopic slide-outs.

EAN: 4003482 04840 5

Price and lead time on demand.



Fire Resistant Document Safes – OfficeDoku

Office Doku 121 - 124

FIRE GRADE S 60 P AND RESISTANCE GRADE II



- document safe, protection against burglary and fire
- 2 security grades in one, type tested and supervised burglary protection by ECB-S
- body double-walled, compound-filled with fire protecting material
- door double-walled
- solid three-sided locking through round bolts of 28 mm Ø, additional round dog bolts on hinge side
- prepared for floor fixing with fixing material, 1 centrally arranged drill hole on the bottom

- fire protection: S 60 P (RAL-RG 626/7) (1 hour fire test for paper)
- body with specially designed fire fold
- depth for files of common size, 2 adjustable shelves, also available with interior safe
- standard series version painted light grey RAL 7035, armature black



More security:

- non-resettable double emergency re-locking mechanism within the door mechanics



OfficeDoku 124 S



Version S

Resettable, armoured high-security safe lock, 'SecuSafe', ECB-S certified according to EN 1300 class B, with 2 keys, 10 levers, key retaining, 50.000.000 key differs. The locking armature protrudes 25 mm. More security in case of losing the key – immediately resettable to a new key.

For detailed information on the resettable high security safe lock SecuSafe see p. 130.

Art.-No.	EAN	Exterior H x W x D mm	Interior H x W x D mm	Door H x W Opening mm	Weight kg	Volume l
OfficeDoku 121 S	30730 4	626 x 641 x 555	476 x 498 x 336	476 x 498	300	79,6
OfficeDoku 124 S	30770 0	1096 x 641 x 555	946 x 498 x 336	946 x 498	450	158,3



Version E

Electronic combination lock 'SecuTronic', with integrated fingerscan module, VdS approved class 2. With intelligent menu-driven operation, administration of up to 10 user codes, up to 20 fingerscans and up to 300 optional TSE E-KEY. User names, access times and -rights, calendar functions, etc. programmed via optional TSE software packages. Incl. 2 batteries Mignon LR 6 AA. The locking armature protrudes 50 mm.

Art.-No.	EAN	Exterior H x W x D mm	Interior H x W x D mm	Door H x W Opening mm	Weight kg	Volume l
OfficeDoku 121 E	30720 5	626 x 641 x 555	476 x 498 x 336	476 x 498	300	79,6
OfficeDoku 124 E	30760 1	1096 x 641 x 555	946 x 498 x 336	946 x 498	450	158,3



OfficeDoku 124 E

Interior safe for Office Doku 121 + 124

It is also possible to assemble various interior safes (interior depth 290 mm) one below the other.

Art.-No.	EAN	suitable for:	H x W x D mm
IT - Office 1	15230 0	Office Doku 121 + 124	151 x 498 x 303

Key sets for OL 121+124 Doku

Detailed information regarding the resettable high security safe lock 'SecuSafe' see p. 130.

Key Set	EAN	
Set 55 GLK-2	09270 5	two key set, length 162 mm with hinge
Set 55 GLK-4	09290 3	4 key set, length 162 mm with hinge
Set 55 GLK-6	06900 4	4 key set, length 162 mm with hinge
As per sample	08790 9	6 key set, Length of key 162 mm with hinge

Models Office 111 E - 116 E, Office 121 E - 126 E Office Doku 121 E - 124 E are all equipped with fingerscan module

For more information please see page 144.



The BURG-WÄCHTER safes of this series comply to the specifications of the European norm EN 1143-1 and/or EN 1047-1. This is approved by the ECB-S certificates of the European Certification Board • Security systems (Certification authorities according to EN 45001). The ECB-S certification includes multiple unannounced inspections of the production sites. Hereby a constant quality level is guaranteed. Errors and omissions excepted.





Data safety cabinets



Data safety cabinets SAFE-DIS 440 E – 446 E FIRE GRADE S 120 DIS AND RESISTANCE GRADE II

- approved security according to EN 1143-1 and EN 1047-1
- fire protection tested according to grade S 120 DIS (fireproof for 2 hours for disks)
- BURG-WÄCHTER data safety cabinets with individual equipment
- gasproof and waterproof
- colour: RAL 7035, light grey
- exterior depth: locking armature protrudes 85 mm
- standard version with 2 possibilities for floor fixing
- prices of Safe DIS 440-446 excluding accessories
- left-sided hinge according to DIN is available at an extra charge
- with automatic lock



Safe-DIS 441 E



Version E

Programmable electronic combination lock 'SecuTronic', ECB-S certified according to EN 1300 class B. 111.000.000 combinations possible, incl. 3 batteries Mignon LR 6 AA.

Art.-No.	EAN	Exterior H x W x D	Interior H x W x D	Weight	Volume
	40 03482...	mm	mm	kg	l
Safe-DIS 440 E	24450 0	730 x 786 x 918	332 x 446 x 478	320,0	71,0
Safe-DIS 441 E	24460 9	1050 x 786 x 918	652 x 446 x 478	460,0	139,0
Safe-DIS 442 E	24470 8	1293 x 786 x 918	895 x 446 x 478	543,0	191,0
Safe-DIS 444 E	24480 7	1850 x 786 x 918	1450 x 446 x 478	785,0	310,0
Safe-DIS 446 E	24490 6	1850 x 1193 x 918	1450 x 855 x 478	1150,0	590,0



Safe-DIS 444 E

Accessories for SAFE-DIS 440 - 446

Art.-No.	EAN	Description
	40 03482...	
430-40	24210 0	partitioned shelf 440-444
434-60	24330 5	partitioned shelf 446
430-30	24170 7	telescopic pull-out partitioned shelf 440-444
434-67	24290 2	telescopic pull-out partitioned shelf 446
430-75	24190 5	basket for CD-ROM (30 pcs) + 5 1/4" optical disk (30 pcs.)
430-42	24230 8	adjustable partition for 430/30
434-42	24350 3	adjustable partition for 434-67
430-25	24240 7	interior safe for files for 440-444
434-25	24360 2	interior safe tray in two parts for 446



Utilisation of the interior space

Freestanding home safes C 1 - C 4, H 3

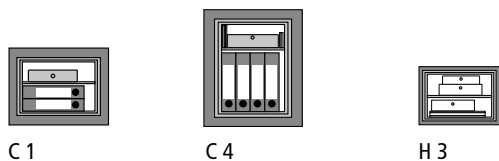

C 1 C 4 H 3

Safety cabinets Combi-Line CL 10 - CL 40

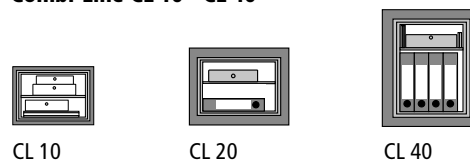

CL 10 CL 20 CL 40

Domestic freestanding safes MT 24 N - MT 26 N

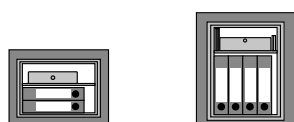

MT 24 N MT 26 N

Commercial freestanding safes MTD 34 - 38 F60

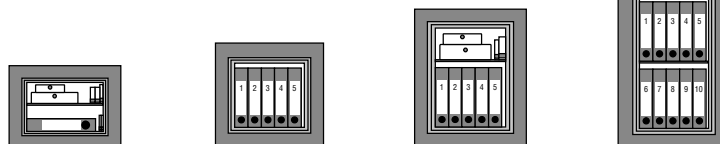

MTD 34 F60 MTD 35 F60 MTD 36 F60 MTD 38 F60

Safety cabinets OfficeLine 101 - 106, Safety cabinets OfficeLine 111 - 126



OL 101 OL 102 OL 104 OL 106
OL 111 OL 112 OL 114 OL 116
OL 121 OL 122 OL 124 OL 126

High quality commercial safes ROYAL sizes 2 - 8



size 2 size 4 size 6 size 8

Examples for the individual utilisation of the interior space

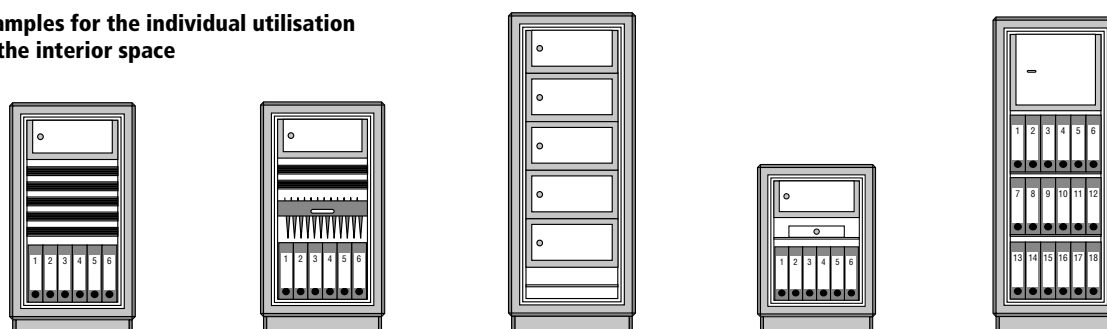

Interior safe IT 2 (tall)



Interior safe IT 1 (small)



Telescopic pull-out shelf



Telescopic pull-out hanging frame for e.g. DIN A 4 files





Telescopic pull-out hanging frame for e.g. EDP files



Shelf with folders







Small size and weight differences reserved. Printing and typographical errors as well as technical changes reserved.

Safe-locks

Level	Version	Certification	Special features	Installed in series	Page
 LEVEL 0 2 5 10	S	none	6 levers	PointSafe P 1-P 3 S, PW 1-3 S	136/143
 LEVEL 0 5 10	S SecuSafe	VdS-tested, ECB-S-certified EN 1300 class A	9 levers, 1 million key differs	H 3 S, WT 11-13 S, CW 5 350, CL 10 - CL 40 S Ranger R S1 5+7 S Ranger A 5 S und W 7 A/B S	135 142/143 133 144/145 147
 LEVEL 0 5 10	S SecuSafe	VdS-tested, ECB-S-certified EN 1300 class B	10 levers, resetable, key retaining, 50.000.000 key differs	MTD 34 - 38 F60 S, MT 24-26 N S C 1-4 S, WT 14-16 N S, Ranger I / 8 S Office 101-126 S Office-Doku 121-124 S ROYAL E 512 S - 558 SS	129/131 134/141 146 152-154 155 148/149

Multiple safes can be instantly re-programmed by the user to be keyed alike. This is ideal for customers who want more than one safe to work with the same key. The innovative technology ensures that these locks have an extremely high tamper resistance, resistance to violent attacks and a maximum service life.

Electronic combination locks

Level	Version	Certification	Special features	Installed in series	Page
 LEVEL 0 2 5 10	E	none	Electronic combination lock with user programmed master- and usercode, Key override for emergency opening.	Pointsafe P 1-4 E, PW 2-3 E Point P 3 E Lap FP 4 E	136/143 137 138
 LEVEL 0 5 7 10	E SecuTronic	VdS-tested, ECB-S-certified EN 1300 class B	1.000.000 different combinations possible, one 6-digit code	H 3 E, C 1-4 E, CL 10-40 E WT 13 E, Ranger A 5 E & W 7 A/B E Ranger I/8 E, Office 101-106 E	132-135 142 147 146 152
 LEVEL 0 5 10	E SecuTronic	VdS-tested, ECB-S-certified EN 1300 class B	1.000.000 different combina- tions possible, up to 10 user- codes programmable, max. 300 optional TSE E-Keys	Karat MT 24-26 N E WT 14-16 N E SAFE-DIS 440-446 E	131 141 156
 LEVEL 0 4 10	E FS	none	Electronic combination lock with fingerscan and user- programmed master- and usercode, additional lock for emergency opening	Pointsafe P 2-4 E FS Point P 3 E FS Lap	136 137
 LEVEL 0 8 10	E FS	VdS-tested, EN 1300 class 1	1.000.000 different combinations possible, one 6-digit code and up to 10 fingerscans	CL 10-40 E FS	133
 LEVEL 0 5 10	E FS	VdS-tested, ECB-S-certified EN 1300 class B	1.000.000 different combinations possible, up to 10 usercodes, up to 20 fingerscans and max. 300 optional TSE E-Keys	MTD 34 - 38 F60 E MT 24-26 N E FS WT 10 E, WT 14-16 N E FS Ranger R S1 5+7 E Office 111-126 E Office-Doku 121-124 E ROYAL E 512 E-E 538 E	129 131 140/141 144/145 153/154 155 148/149

Locking systems for safes with the highest standards in the commercial sector can be found on page 150.



Overview of certifications and security levels



The VdS tests and certifies products around the topic of security. The BURG-WÄCHTER safe locks SecuSafe and SecuTronic achieve high resistance values in the audited lock classes. The accurate performance and classification of the locks can be found on the opposite side (left). The VdS label stands for quality and reliability.

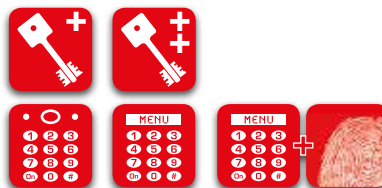

Many BURG-WÄCHTER safes meet the requirements of European Standards EN-1143-1 and/or EN 1047-1. This is confirmed in the ECB•S certification of the European Certification Board • Security Systems (certification body according to EN 45011) The ECB • S certification includes a multi-annual unannounced inspection of the production sites. Thus a consistent level of quality is guaranteed. All details are without guarantee.



Insurance coverage of the various security levels see next page 160 —>



Safes with this symbol meet the technical requirements of the standard sheet 24992, May 1995. BURG-WÄCHTER is a member of the Association „FV security systems“ within the VDMA, Frankfurt.



This label says: Thoroughly tested in the BURG-WÄCHTER laboratory. To ensure reliable quality even for inexpensive safes.



These safes are characterised by a particularly high level of fire protection.



BURG-WÄCHTER classifications

BURG-WÄCHTER safes correspond to the highest level of technology and are recognised internationally.

BURG-WÄCHTER is a member of the Association „Security Systems“ VDMA and the European Security Systems Association (ESSA).

Technical changes may lead to dimension and design modifications.



BURG-WÄCHTER safes correspond to the highest state-of-the-art technology and are internationally recognized. BURG-WÄCHTER is member of the VDMA security systems association and European Security Systems Association (ESSA e. V.). Changes in dimensions and constructions of wall safes and freestanding home safes can occur due to technical production changes.

Sums insured in Europe

Safety cabinets EN 14450 / Safes EN 1143-1

Overview of insured sums in 1,000 € (mean values) in selected European countries								
	EN 14450		EN 1143-1					
	S1	S2	0	I	II	III	IV	V
Austria private sector (without EMA)	n. a.	n. a.	20	65	100	200	400	n. a.
Austria private sector (with EMA)	n. a.	n. a.	40	130	200	400	800	n. a.
Austria commercial/ industrial sector (without EMA)	n. a.	n. a.	10	20	50	100	150	250
Austria commercial/ industrial sector (with EMA)	n. a.	n. a.	20	40	100	200	300	500
Belgium	1,8	2,5	7,3	24,7	37,2	74,3	111,6	148,7
Czech Republic	4	6	12	20	48	160	240	600
Denmark (without EMA)	0,5	1,5	2	5	8	27	67	121
Denmark (with EMA)	1	2	4	11	16	81	202	n. a.
France	1,5	3	7,6	25	35	56	107	229
Germany private sector (without EMA)	5	20	40	65	100	200	400	n. a.
Germany private sector (with EMA)	5	20	80	130	200	400	800	n. a.
Germany commercial/ industrial sector (without EMA)	n. a.	n. a.	10	20	50	100	150	250
Germany commercial/ industrial sector (with EMA)	n. a.	n. a.	20	40	100	200	300	500
Great Britain*	3	6	9	15	26	51	88	146
Hungary (without EMA)	6	10	20	31	78	n. a.	n. a.	n. a.
Hungary (with EMA)	12	20	40	62	156	272	467	1.170
Italy	10	25	52	103	258	413	568	723
Norway (without EX certification)	2,5	4,5	6	9	15	22	35	59
Norway (with EX certification)	n. a.	n. a.	n. a.	n. a.	22	35	59	106
Portugal	1,5	3	7,6	25	35	56	107	229
Slovakia (without EMA)	n. a.	n. a.	n. a.	6	15	31	62	124
Slovakia (with EMA)	n. a.	n. a.	n. a.	25	92	246	492	738
Slovenia (without EMA)	2	4	8	17	42	83	125	209
Slovenia (with EMA)	4	8	16	34	84	166	250	418
Spain	1,5	3	7,6	25	35	56	107	229
Sweden	n. a.	n. a.	5,6	8,9	15,6	23,5	39	61
Switzerland (without EMA)	n. a.	n. a.	n. a.	30	60	120	300	450
Switzerland (with EMA)	n. a.	n. a.	n. a.	60	120	300	600	900
The Netherlands	2,5	5	7	9	23	36	55	82

(NOTE: The mean values of the sums insured mentioned in €1000 apply - if no other information is presented - both for the private as well as for the commercial and industrial sector.)

Note: EMA: Intrusion detection system

EX: Protection against attacks with explosives

* Sums insured, according to ECB • S
– these may differ from the sums according to AiS



BURG WÄCHTER safes correspond to the highest level of technology and are recognised internationally. The BURG WÄCHTER safes of the KARAT, DIPLOMAT, OFFICE and ROYAL series meet the requirements of European Standards EN-1143-1 and / or EN 1047-1. This is confirmed in the ECB•S certification of the European Certification Board • Security Systems (certification body according to EN 45011). The ECB•S certification includes a multi-annual unannounced inspection of the production sites. This guarantees a consistent level of quality. All data without guarantee!



**BURG
WÄCHTER**

How do I find the perfect safe for my needs?

Based on our checklist, you quickly gain an overview which model is right for you.

SIZE

How much space do I need? What do I need to keep secure?

- folders, insurance policies
- important documents (family register, ...)
- jewellery boxes, keys, etc.
- laptop, camera
- cash, credit cards
- weapons and ammunition

POSITION

Where do I want to position my safe?

- built into the wall (to save space)
- in a wall unit (fixing by the back wall)
- free positioning in the room (wall/ floor anchorage)

LOCKING SYSTEM

Which locking system is right for me?

- key lock
- electronic combination lock
- electronic combination lock with a fingerprint scanner module (very fast and convenient)

Use our detailed overview on page 158!

SECURITY

How big is my need for protection?

- protection against burglary
- protection against burglary and fire

For more information about certifications and security levels see pp. 158 and 159.

Notes:

Tip:

You should choose a larger model, so you have enough spare space for the future.

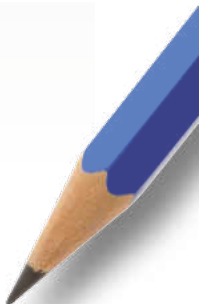



General terms and conditions

Section 1 Applicability

1. These General Terms and Conditions apply exclusively; any purchaser's opposing conditions or terms differing from our Terms and Conditions shall be rejected if not explicitly approved in writing. Our terms of sale, delivery and payment also apply in case we perform a delivery without reservation to the purchaser while being aware of opposing or differing terms of the purchaser.

2. Our terms of sale, delivery and payment also apply for any future business transactions with the purchaser.

Section 2 Quotations

1. Our specifications relating to prices, quantities, delivery dates and possible deliveries are non-binding. We shall be bound to our quoted prices for a period of 60 days from the date of quotation if not otherwise agreed in writing. We reserve the right to implement changes in dimensions and colours, as well as technical modifications. Minor differences in weight and dimensions are due to the production process.

2. We reserve the right of ownership and intellectual property rights to any graphical representation and images, concepts, calculations and other materials. The indicated materials may not be made available to a third party without our explicit written consent. The use of image data requires a separate agreement.

Section 3 Terms of pricing and payment

1. If not otherwise agreed in writing, the billing shall be made in euros. The prices are quoted within Germany with a free delivery from € 200. Different terms for deliveries from 100 kg or for islands to be requested.

Our prices are quoted for a purchase of original packaging units. When a smaller quantity is ordered, we are entitled to bill a surcharge at 25% of the purchase price.

2. All the prices we indicate are net prices; they are to be understood excluding VAT in the applicable amount as at the invoice date.

Our invoices are due in 30 days from the invoice date net with no discount. We provide a discount of 2% for payments within 20 days and 3% for payments within 10 days. The entitlement to any discount becomes void in case older invoices are overdue. These provisions do not apply to invoices for repairs and installation, as well as to any billing for equipment, which are always due immediately and with no discount.

In case any payment or its part is overdue, the purchaser is considered in delay even without any dunning or reminder notice. We are entitled to charge interests on late payments in the amount of the current bank rates for overdraft credits.

3. The purchaser is entitled to perform an offset only if its counter claims have been legally recognized and they are uncontested or if they have been recognized by us. Furthermore, the purchaser is entitled to exercise a right of retention only insofar as its counter claim is based on the same contractual relationship as the payment claim.

Section 4 Delivery and delivery time

1. The beginning of the delivery time as agreed is conditional upon the clarification of all technical aspects. Any goods purchased based on a release order shall be released within 12 months, provided no different explicit arrangement is agreed. When such a period expires, we are entitled to deliver the goods disregarding any restriction, without having to wait for a release order.

The adherence to the agreed delivery time or to the rightfully determined delivery scheduling is conditional upon us being delivered any primary materials or purchased parts from our subcontractors in due time as ordered and as necessary for the accomplishment of the purchaser's order (with the reservation of

a self-delivery). In case we are not able to adhere to the delivery times as agreed or as rightfully determined as a result of a late delivery by our subcontractor, we shall not be considered in delay, provided the primary materials had been ordered in due time and we have undertaken reasonable efforts to ensure a delivery of primary materials in as due.

2. Both compensation claims by the purchaser based on a delayed delivery and any indemnity claims as a replacement of delivery exceeding the limits as set out in par. 1 are excluded in all cases of a delayed delivery, also after the expiry of any period for delivery imposed on us. This does not apply to the extent of legally imposed responsibility in case of intent or gross negligence or of injury to life, body or health; this constitutes no alteration of the burden of proof to the detriment of the purchaser.

The purchaser is entitled to rescind the contract within the framework of applicable legal provisions, insofar as the delay in delivery is imputable to us.

3. If the purchaser is in delay with acceptance or if the purchaser infringes on any other duty to cooperate, we are entitled to claim the damage incurred, including any additional expenditures. In such case, also the risk of accidental deterioration or of accidental degradation of the goods is transferred to the purchaser at the moment the purchaser is in delay with acceptance.

4. If no other arrangement is made, we are entitled to partial deliveries. The purchaser is not entitled to refuse partial deliveries, unless they are impracticable for the purchaser because of the nature of the purchaser's contractual obligations or because of the properties of the goods or their intended use.

Section 5 Risk transfer

The shipment is always made at the purchaser's account and risk. This also applies when the goods is shipped to another address as required by the purchaser. For the purpose of shipment, we always choose the way appearing to be most advantageous.

Immediately after the delivery, the purchaser shall check the goods with regard to their completeness and any identifiable damage and notify us about any loss or damage found within 5 days from the receipt of the shipment.

Section 6 Terms of warranty

1. Any warranty rights of the purchaser are conditional upon the purchaser's compliance with its obligations regarding inspection and notification according to §§ 377, 378 of the German Commercial Code (HGB). §§ 377, 378 HGB also apply mutatis mutandis when we only provide a pure service to the purchaser.

2. Insofar as the purchased item is defective, we are always first entitled to be granted the opportunity to provide supplementary performance according to § 439 of the German Civil Code (BGB).

3. Unless otherwise specified below, any other claim by the purchaser – irrespective of its legal basis – is excluded. We shall therefore not be held liable for damage not occurring to the delivered item itself; in particular we shall not be held liable for any lost profit or any other financial loss of the purchaser.

The aforementioned exclusion of liability shall not apply insofar as the cause of damage is based on intent or gross negligence, as well as in case of injury to life, body or health. It shall also not apply insofar as we have assumed a guarantee for the properties of the particular item or for its durability. The aforementioned exclusion of liability shall also not apply to such damage, which was caused by culpable violation of material contractual obligations (these are obligations, the fulfilment of which is a prerequisite for enabling proper performance of the contract, and the observance of which can be, as a rule, replied upon by our contractual partner); in such case, provided no intent or gross negligence exist and we have assumed no guarantee, our liability shall be limited to foreseeable damage typical

for the particular type of contract.

4. If the delivered goods is defective or lacking any properties as promised, or if it becomes defective during the warranty period, we reserve the right of supplementary performance. At our discretion and with the exclusion of any additional warranty rights, we will provide either for remedy of the defect or for a replacement delivery.

In the event that and only if such supplementary performance is unsuccessful, we will take the product back. Upon identification of such defects, specifically within 10 days from acceptance in case of identifiable defects and without delay after identifiability in case of non-identifiable defects, we shall be promptly notified on them in writing. However, the warranty period expires, at the latest, 24 months from the day the goods have been dispatched from our plant.

The warranty becomes void in case of improper usage of goods, in case of other than designated use of goods or when the goods are modified by the purchaser or by a third party.

The contractual item is exclusively the goods sold with the properties and characteristics, as well as the designated purpose, in compliance with the attached product description. Other or additional properties and/or characteristics or an additional designated purpose shall be deemed agreed only if explicitly confirmed by us in writing.

Return of goods can only be carried out after a written agreement. It is necessary to attach the goods return accompanying certificate on the outside (to be provided by BURG-WÄCHTER).

Any returned goods without the accompanying certificate cannot be processed.

The return delivery address is:

BURG-WÄCHTER KG, Wormgermühle, D-58540 Meinerzhagen

A minimum deduction of 25% is charged for any return not caused by BURG-WÄCHTER. Custom-made items (mailbox systems, locking systems, etc.) cannot be returned.

Section 7 Total liability

1. Any further liability for compensation and reimbursement of expenses than that specified in § 6 – irrespective of the legal nature of the claim presented – is excluded. This provision does not apply to claims, which are made against us according to §§ 1 and 4 of the German Product Liability Act (Gesetz über die Haftung für fehlerhafte Produkte). The exclusion of liability shall also not apply in case of intent, gross negligence, injury to life, body or health, as well as in case of breach of material contractual obligations (so called "cardinal duties").

However, the claim for compensation in case of breach of material contractual obligations shall be limited to foreseeable damage typical for the particular type of contract, provided no intent or gross negligence exist or liability for injury to life, body or health is imposed. The aforementioned provisions do not constitute an alteration of the burden of proof to the detriment of the purchaser.

2. Insofar as our liability is excluded or limited, the same exclusions and limitations apply to personal liability of our employees, personnel, staff, representatives and agents.

Section 8 Retention of title

1. We retain the ownership of the purchased item until the purchase price has been fully paid including any additional costs incurred (transportation, packaging etc.). In the event of an action in breach of contract by the purchaser, in particular in case of delayed payment, we are entitled to rescind the purchase contract and recover the purchased item. After the recovery of the purchased item, we are entitled to sell it; the proceeds from such sale after a deduction of reasonable selling costs shall be credited to the purchaser's

liability.

2. The purchaser shall treat the purchased item with care. At its own expense, the purchaser shall insure the purchased item sufficiently at the original value against damage caused by fire, water and theft.

3. In the event of seizure or other similar action by a third party, the purchaser shall notify us immediately in writing. In such an event, the purchaser is further obliged to support us fully in judicial or extrajudicial assertion of our rights, in particular to provide us with any required supporting documents.

4. The purchaser is entitled to resell the purchased item in a regular course of business; however, the purchaser assigns to us already now all receivables up to the total of the final invoice amount (incl. VAT) arising from such resale to its customers or third parties. This assignment applies irrespective of whether the purchased item is resold without or after being further processed. We hereby accept this assignment.

The purchaser remains entitled to collect the debt within the framework of a regular course of business. This entitlement becomes void if the purchaser no longer meets its payment obligations associated with the collected proceeds, or in case of the purchaser's delayed payment. It also becomes void in the event of an application to open insolvency or composition proceedings on the assets of the purchaser or in case the purchaser discontinues its payments.

In such events we are entitled to collect the assigned debt ourselves. The purchaser shall provide us with any information required in order to collect the debt and with the associated documents. In such case, the purchaser shall notify the debtor (the third party) about the assignment of debt.

5. The processing or transformation of the purchased item by the purchaser shall always be accomplished for us. If the purchased item is processed together with other items not belonging to us, we shall be granted co-ownership of the new item proportionally to the value of the purchased item compared to the value of the other items processed as at the time of processing. As for the rest, the same provisions applying to the purchased item delivered by us shall equally apply to the newly created item.

6. If the purchased item is inseparably mixed with other items not belonging to us, we shall be granted co-ownership of the new item proportionally to the value of the purchased item compared to the value of the other mixed items as at the time of processing. If the mixing is carried out in such a way that the purchaser's item can be regarded as the main item, it is agreed that the purchaser shall assign co-ownership to us in the proportional amount. The purchaser shall hold the ownership or co-ownership resulting from this for us.

7. We undertake to release the collateral due to us at the request of the purchaser insofar as the marketable value of our collateral exceeds the claim to be secured by more than 20%; the selection of the collateral to be released is our responsibility.

Section 9 Place of execution, applicable law and jurisdiction

1. Unless otherwise contractually agreed, the place of execution is the registered office of our company.

2. Any business relationship with us is governed exclusively by the law of the Federal Republic of Germany. Application of the CISG (UN Convention on Contracts for the International Sale of Goods) is excluded.

3. If the purchaser is a merchant, any legal disputes internationally shall be subject to the courts of the Federal Republic of Germany.

In any case, the place of jurisdiction is the registered office of our company. However, we are entitled to sue the purchaser at its general place of jurisdiction. These regulations of jurisdiction also apply to claims arising out of any bill of exchange or cheque.

VAT ID No.	DE 126881184
DSD license no.	11473
Interseroh no.	2088148
ILN	40 03482 00000 7
WEEE reg - no.	DE19767115



Index

Art.-No.	Page	Art.-No.	Page	Art.-No.	Page	Art.-No.	Page	Art.-No.	Page
116 PC	14	891-893	114	Door lifter	60	Letter boxes for 'through		R 100-160	20
116 Profi	9	90 Chromo	17	Door lock TSE	33	the wall' installations	109	Reflex	23
1220-1260	24	900 Titan	8	Door locks BlockSafe	53	Letter boxes for		Roma	101
124 My favorite padlock	18	916/91600	99	Door spyhole	51	fence fixing	104	Rondo	114
1345-1360	25	926/92600	99	Door wedge	64	Letter boxes made		Royal	74
1500 HB	27	942 Jumbo	113	Doorstops	60	of high quality plastic	83	Royal safes	148
1550-1555	25	94-95	16	Doorstops	61	Letter boxes made of		Rustproof locks	11
1650 Reflex	25	95 Fun	17	Dry	69	solid cast aluminium	94	Safes	127
1842 Roma	97	99 Ni	17	Dual	116	Letter plates	108	Safety cabinets	152
1867 Bayreuth	97	All-round cam locks	28	E 7/700	31	Locate	68	Security inserts	31
1883 Sylt	96	Alpha	8	eBoxx	120	Lock bolt	21	Security locking bolts	20
1890-1899	94	Amrum	90	Electronic door locks	33	Lock blocking keys	31	Sheet metal padlocks	18
21 Circle	18	Amsterdam	100	Emergency		Lock-sets	14	Shutter lock	12
2127-2307	74	Atlanta	85	key cabinets	78	Look	15	SKM	26
217, 217 Ni	10	Atlantic	10	Energy	70	Love locks	15	Slot	77
22 Diskus	18	Barrel bolt	21	ESA	31	Lucca	90	Snap+Lock	27
220-230	23	Bayreuth	101	Esprit	87	Luggage balance	71	SR 60-120	21
222 C-Line	12	Bicycle locks	22	Europa	115	Luxury bolt	50	Stainless steel	
240-260	22	Biometrics	145	Moisture meter	69	Magdeburg	101	key boxes	77
250-350	74	Block safe	53	Fire protective safes	138	Magno	13	Stainless steel bolts	21
320-345	22	Boccia	10	Fingerscan safes	128	Mailbox	114	Stainless steel	
3680-3780	89	Bolts	20	FP 4	138	ME	31	letter boxes	88
3713/0	91	Bordeaux	94	Freestanding safes	132	Measuring tools	65	Stand Universal	112
3816 Hanseatic	88	Borkum	93	FTA 2005	51	Micrometer	72	Swing	86
3843-3844	88	Bremen	84	Fun 95	17	Milano 3843	88	Sylt	97
3867/0	91	Business	74	Furniture locks	29	Milano 843	96	Tara	71
3877-3878	93	Cable locks	22	Futura	98	Modena	92	Temperature gun	70
3913/0	91	Cables	27	Gamma	8	Money	75	Terzo	114
393-398	19	Caliper	72	GKM	26	MS 90-92	29	TF	60
400 Magno	13	Cash boxes	74	GR 50-70	21	MT 24-26	131	TH	60
402 Look	15	Chains	26	Gun cabinets	144	MTD 34-38	129	Tire pressure meter	70
444 Quadra	12	Circle	18	Gun lock	32	Multifunction		Titan	8
450 Boccia	10	City-Line	134	GunLock	32	detectors	68	TK 64-75	50
460 Ni	11	CKS 167-307	75	Hand balance	71	Multimeter	71	TS 1500/2000	56
4901 Atlanta	85	CL 10-40	133	Hannover	92	MZ 23-83	30	TS 4000/5000	57
4905-4906	86	Classico	86	Hanseatic	88	News	110	TSA 77	16
4911-4932	87	C-Line	12	Hasp & staples	20	Nordic- stainless steel	89	TSB/TSW	61
500 Point	15	Coil cable	27	Holiday	103	Nordic- stands	113	TSE 4001	35
550-570	22	Coil cable locks	24	Homesafe	134-135	Nordic- steel		TSE Business	36
5832/5861	101	Combi 71 - 88	16	Hotel safes	137	letter boxes	95	TSE Software	48
5842 Holiday	97	Combi-Line	133	Impression	85	Numero	16	TSE System	42
600 Diamant	8	Combination		Jumbo	113	Nuvola	77	Two - wheeler locks	22
630 Schloss	19	coil cable locks	23	Karat 217	10	Office cash boxes	74	'U' Shackle locks	27
650 Reflex	23	Combination padlocks	16	Karat MT	131	Office safes	152	Universa- cash boxes	75
6500-6750	79	Comfort	90	KB 15-35	78	Olymp	98	US-Mailbox	114
6800-6900	80	Commercial safes	129	Key boxes	78	Opera	89	Varese	77
680-780	95	Commercial safes	148	Key cabinets	79	PA 2006	51	Vario-Set	100
700 Gamma	8	Como	77	Key racks	80	Paper boxes	110	Venezia	94
70-77	16	Counting tray		Key safes	139	Parcel box	122	Verona 3844	88
7167-7300	74	cash boxes	76	KeySafe	139	PC 60-120	20	Verona 844	96
720/750	27	Cross	66	Kiel	84	PCC 60-120	21	Vivo	87
731-732	113	CS 15-42	78	Köln	106	Pearl	83	VTK	50
767 Magdeburg	101	Cylinder padlocks	9	Kopenhagen	97	Personal alarm	51	Wall safes	140
770 Alutitan	11	Data safety cabinets	156	Laptop safes	137	Piano	83	Window alarm	51
771+772	106	Design locks	11	Laser angle	66	PK 1-4	20	Window locks	50
777 Leipzig	104	Diamant	8	Laser meter	67	PL 2-3	20	Window security	52
778+878	102	Diplomat	129	Leipzig	104	PMG 80-100	20	Window security grills	55
794-797	107	Diskus	18	Letter	102	Point	15	Winprotec	55
80 Combi	17	Distance meter	66	Letter box accessories	125	Pointsafes	136	Winsafe	52
800 Alpha	8	Document safes	155	Letter box banks	106	Porta	106	Wismar	108
800-820	110	Door and window		Letter box frame	107	Potsdam	104	WT 10	140
821-822	116	equipment	49	Letter box stands	112	Precise	72	WT 11-16	141
867/86720	100	Door chains	50	Letter boxes		Profi	9	Yacht 460	11
871+872	107	Door closer	56	- freestanding	115	Profiscale	65	ZBK 70-75	29
877 Potsdam	106	Door closer 501-504	58	Letter boxes - replacement		Puck	61	ZS 61-85	28
882 Kopenhagen	97	Door closer		cylinders	28	Quad	77		
885-886	84	with slide rail	58	Letter boxes	81	Quadra	12		
889-898	85	Door eGuard	51	Letter boxes 'Point'	102	Quadus	89		



**BURG
WÄCHTER**

Lined writing area consisting of 18 horizontal dotted lines for text entry.